



# ***GAS TAPS***

G

Gas taps

## ***Gas taps***

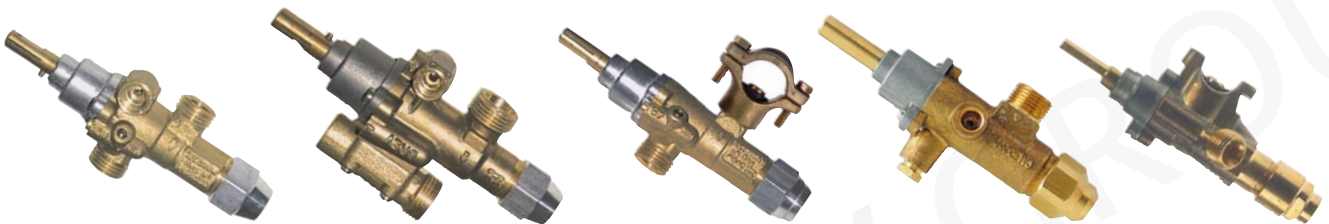

**G.E.V. Großküchen-Ersatzteil-Vertrieb GmbH**  
Robert-Koch-Straße 3a  
82152 Planegg/Munich  
Germany

Phone: +49 (0)89 745572-0  
Fax: +49 (0)89 745572-83  
order@gev-online.com  
www.gev-online.com

Member of the  **GEV GROUP**

## Gas taps MADEC

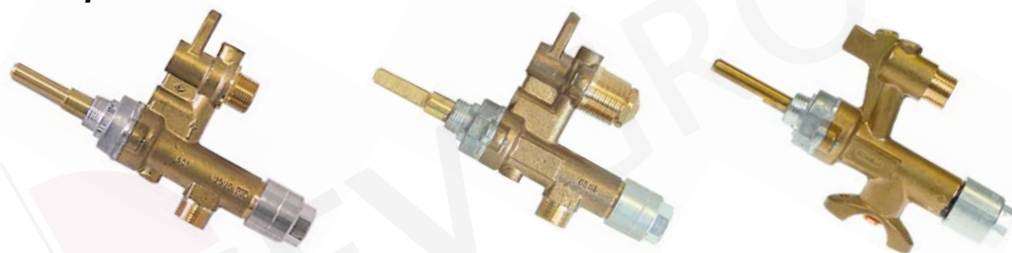

page 4

## Gas taps PEL 20/21



page 6

## Gas taps PEL 22/23



page 8

## Gas taps EGA 26400/26440/24197



page 14

## Gas taps EGA/PEL 20/21/22



page 20

## Gas taps JUNKERS



page 24

G  
Gas taps

---

**Gas taps STN3R**



**page 26**

---

**Gas taps COPRECI**



**page 27**

---

**Gas taps SABAF**



**page 28**

---

**Various gas taps**

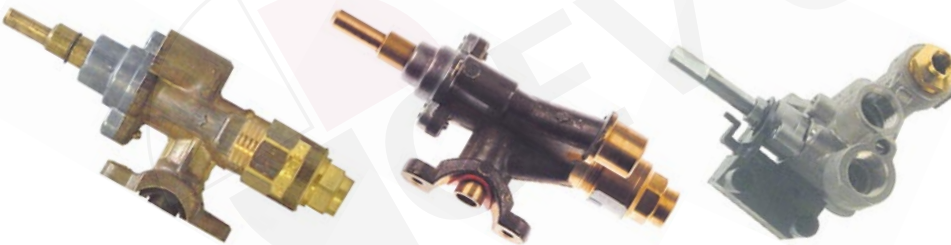

**page 29**

---

## gas taps MADEC

© GEV 2007



item	order no.	description	gas input	ø nozzles (mm)			mixing pipe connection	pipe		thermocouple connection	front fixing	L1/L2 (mm)	spindle (mm)
				external nozzle	internal nozzle	bypass nozzle		output	ø (mm)				
1	101629		M12x1 (8mm)	-	-	0,55	-	M12x1	8	M8x1	M12x1	29,5/21	
	101638	pipe outlet	M12x1 (8mm)	-	-	1,00	-	M12x1	8	M8x1	M12x1	29,5/21	
2	101074		M12x1 (8mm)	-	-	0,35	-	M12x1	8	M8x1	M12x1	29,5/21	
	101072		M12x1 (8mm)	-	-	0,35	-	M12x1	8	M8x1	M12x1	29,5/13,5	
	101193		M12x1 (8mm)	-	-	0,35	M17x1	-	-	M8x1	M12x1	23/13,5	
	101073		M12x1 (8mm)	-	-	0,35	M17x1	-	-	M8x1	M12x1	23/13,5	
3	106034		M12x1 (8mm)	-	-	0,35	M17x1	-	-	M8x1	M12x1	29,5/13,5	
	106174	nozzle outlet without nozzle	M12x1 (8mm)	-	-	0,35	M17x1	-	-	M8x1	M12x1	23/13,5	
	101194		M12x1 (8mm)	-	-	0,35	M17x1	-	-	M8x1	M12x1	17/9	
	101635		M12x1 (8mm)	-	-	0,55	M17x1	-	-	M8x1	M12x1	37/17	
	101374		M12x1 (8mm)	0,85	-	0,50	M17x1	-	-	M8x1	M12x1	29,5/21	
4	101198		M12x1 (8mm)	2,00	0,70	0,35	M17x1	-	-	M8x1	M12x1	29,5/21	
	101381	nozzle outlet with nozzle	M12x1 (8mm)	0,85	-	0,50	M17x1	-	-	M8x1	M12x1	29,5/21	
	101631		M12x1 (8mm)	2,20	1,20	0,55	M17x1	-	-	M8x1	M12x1	37/17	

G

Gas taps

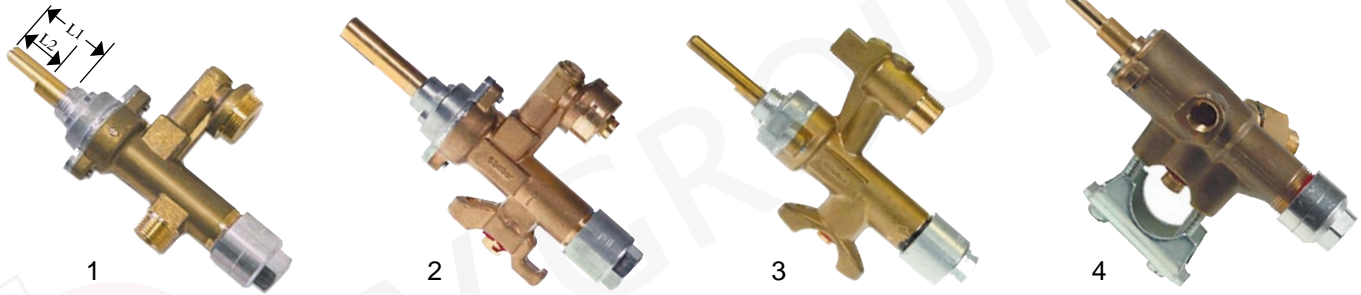

item	order no.	description	gas input	ø nozzles (mm)			mixing pipe connection	pipe output ø (mm)	thermocouple connection	front fixing	L1/L2 (mm)	spindle (mm)
				external nozzle	internal nozzle	bypass nozzle						
1	101192	nozzle outlet without nozzle	M12x1(8mm)	-	-	-	M17x1	-	M8x1	M12x1	23/13,5	
2	106058	nozzle outlet with nozzle	flange connection	1,03	-	-	M17x1	-	M8x1	-	29,5/13,5	
3	106020	pipe outlet with clip connection ø 21mm	flange connection	-	-	1,40	-	M12x1	M8x1	M12x1	29/20	
4	106057	pipe outlet with clip connection ø 21mm	flange connection	-	-	0	-	M12x1	M8x1	-	27/15	

## accessories and spare parts

### external nozzles M12x1



pos.	order no.	ø (mm)	pos.	order no.	ø (mm)	pos.	order no.	ø (mm)
1	100974	0,80	18	100287	1,45	35	100309	2,30
2	100279	0,82	19	100700	1,50	36	100668	2,35
3	100249	0,85	20	100301	1,55	37	100294	2,40
4	100283	0,90	21	100665	1,60	38	100749	2,45
5	100280	0,93	22	100239	1,65	39	100326	2,50
6	100282	0,95	23	100288	1,70	40	100416	2,55
7	100284	1,00	24	100878	1,75	41	100304	2,60
8	100662	1,05	25	100289	1,80	42	100295	2,70
9	100285	1,10	26	100302	1,85	43	100305	3,00
10	100243	1,12	27	100290	1,90	44	100752	3,20
11	100663	1,15	28	100740	1,95	45	100296	3,30
12	100306	1,20	29	100291	2,00	46	100297	3,45
13	100975	1,25	30	100303	2,05	47	100298	3,50
14	100286	1,30	31	100292	2,10	48	100299	3,70
15	100300	1,35	32	100744	2,12	49	100763	3,80
16	100669	1,37	33	100308	2,15	50	102794	3,85
17	100307	1,40	34	100293	2,20	51	100762	4,10

### internal nozzles



pos.	order no.	ø (mm)	pos.	order no.	ø (mm)	pos.	order no.	ø (mm)
1	100325	0,70	5	100788	0,95	9	100423	1,40
2	100419	0,75	6	100449	1,00	10	100771	1,55
3	100421	0,80	7	100422	1,20	11	100770	1,65
4	100774	0,85	8	100772	1,30			

### bypass nozzles



pos.	order no.	ø (mm)	pos.	order no.	ø (mm)	pos.	order no.	ø (mm)
1	100360	0,35	4	100426	0,55	7	100424	0,80
2	100425	0,45	5	100781	0,60	8	100454	1,00
3	100782	0,50	6	100427	0,70			



item	order no.	description	item	order no.	description
1	101277	olive for pipe ø 8mm	4	101051	magnetic shim
2	101296	union nut M12x1 for pipe ø 8mm	5	101234	magnetic shim nut for thermocouple M8x1
3	101299	front fixing nut M12x1			



item	order no.	description	item	order no.	description
1	101400	mixing pipe M17x1	3	101394	nut M17x1
2	101401	mixing pipe M17x1			

## gas taps PEL 20/21



item	order no.	description	gas input	ø pipe input (mm)	ø bypass nozzle (mm)	gas outlet	ø pipe outlet (mm)	thermocouple connection (mm)	L1/L2 (mm)	spindle (mm)
1	101398	PEL20N without safety, without ignition flame	M16x1,5	10	0,35	M16x1,5	10/8	-	22/15	
	101094		M16x1,5	10	0,35	M16x1,5	10/8	M8x1	22/15	
2	101491	PEL20S with safety, without ignition flame	M16x1,5	10	0,35	M16x1,5	10/8	M9x1	22/15	
	101958		M16x1,5	10	0	M16x1,5	10/8	M8x1	39/15	

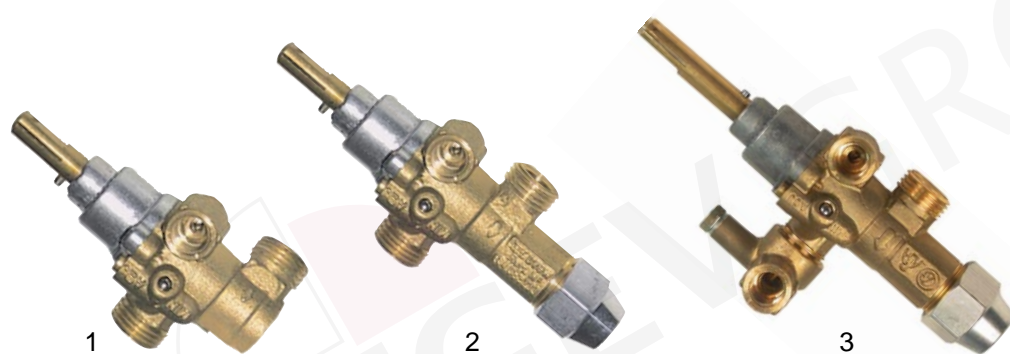

item	order no.	description	gas input	ø pipe input (mm)	ø bypass nozzle (mm)	gas outlet	ø pipe outlet (mm)	thermocouple connection (mm)	L1/L2 (mm)	spindle (mm)
1	101530	PEL21N without safety, with ignition flame	M16x1,5	10	0,35	M16x1,5	10/8	-	22/15	
	101693		M16x1,5	10	0,70	M16x1,5	10/8	M8x1	35/28	
	101913		M16x1,5	10	0,90	M16x1,5	10/8	M8x1	35/28	
	101095		M16x1,5	10	0,35	M16x1,5	10/8	M8x1	22/15	
	101356		M16x1,5	10	0,35	M16x1,5	10/8	M10x1	22/15	
	101883		M16x1,5	10	0,40	M16x1,5	10/8	M8x1	22/15	
	101884		M16x1,5	10	0,50	M16x1,5	10/8	M8x1	22/15	
2	101885		M16x1,5	10	0,80	M16x1,5	10/8	M8x1	22/15	
	106021	PEL21S with safety, with ignition flame	M16x1,5	10	0,95	M16x1,5	10/8	M8x1	22/15	
	101397		M16x1,5	10	0,35	M16x1,5	10/8	M9x1	22/15	
	101917		M16x1,5	10	0,60	M16x1,5	10/8	M9x1	22/15	
	101918		M16x1,5	10	0,65	M16x1,5	10/8	M9x1	22/15	
	101919		M16x1,5	10	0,75	M16x1,5	10/8	M9x1	22/15	
3	106138		M16x1,5	10	0	M10x1	6	M9x1	37/15	



item	order no.	description	ø gas input (mm)	ø bypass nozzle (mm)	gas outlet	ø pipe outlet (mm)	thermocouple connection (mm)	L1/L2 (mm)	spindle (mm)
1	101897	PEL21S with safety, with ignition flame	21	0,35	M16x1,5	10/8	M8x1	32/25	
	101544		21	0,35	M16x1,5	10/8	M8x1	30/23	
	101610		21	0,35	M16x1,5	10	M8x1	30/23	
	101671		21	0,35	M17x1	10	M8x1	30/23	
	101672		21	0,85	M17x1	10	M8x1	30/23	
	101976		21	0,35	M17x1	10	M8x1	30/17,5	
	101682		21	0,35	M17x1	10	M8x1	31/15	
3	106143	PEL20 with safety, without ignition flame	21	0,35	M16x1,5	10/8	M9x1	22/15	

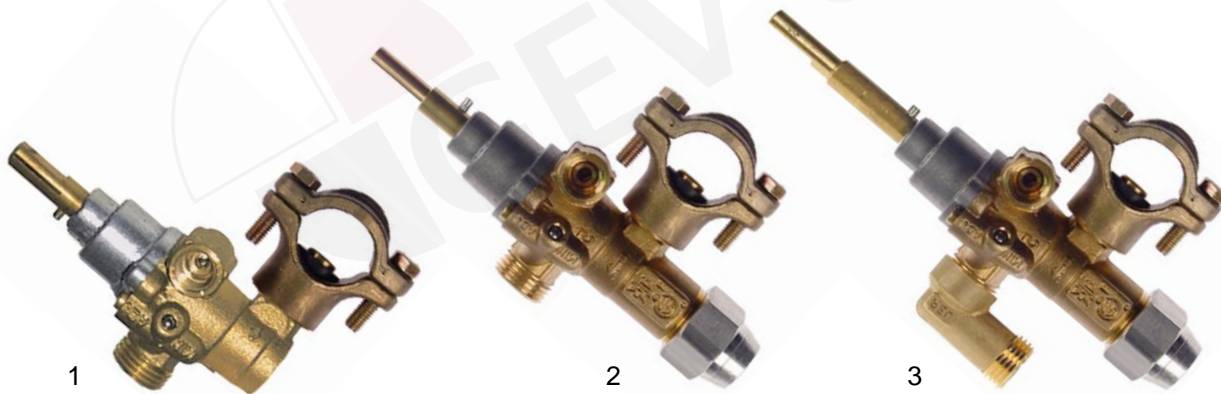

item	order no.	description	ø gas input (mm)	ø bypass nozzle (mm)	gas outlet	ø pipe outlet (mm)	thermocouple connection (mm)	L1/L2 (mm)	spindle (mm)
1	106144	PEL21N without safety, with ignition flame	21	0,35	M16x1,5	10/8	-	22/15	
	106145	PEL21S with safety, with ignition flame	21	0,35	M16x1,5	10/8	M9x1	22/15	
2	101611	PEL21S V with safety, with ignition flame	21	0,35	M16x1,5	10/8	M8x1	30/17,5	
3	106060	PEL21S H with safety, with ignition flame	21	0	M16x1,5	10	M8x1	45/19	

## gas taps PEL 22 PEL 22N without safety



item	order no.	description	gas input	ø pipe input (mm)	ø bypass nozzle (mm)	gas outlet	ø pipe outlet (mm)	L1/L2 (mm)	spindle (mm)
1	101443	PEL22N/O	M20x1,5	12	0,35	M20x1,5	12/10	25/17	
	101690	PEL22N/V	M20x1,5	12	0,35	M20x1,5	12/10	25/17	
2	106169	PEL22N/V	M20x1,5	12	0,35	M20x1,5	12/10	45/20	
	101459	PEL22N/O	ø 21mm	-	0,35	M20x1,5	12	39/7	
3	106157	PEL22N/O	ø 27mm	-	0,35	M20x1,5	14	39/7	



item	order no.	description	gas input	ø pipe input (mm)	ø bypass nozzle (mm)	gas outlet	ø pipe outlet (mm)	thermocouple connection	L1/L2 (mm)	spindle (mm)
1	101084	PEL22S/V	M20x1,5	12	0,35	M20x1,5	12/10	M8x1	45/20	
	101157	PEL22S/V	M20x1,5	12	0,35	M20x1,5	12/10	M8x1	25/17	
	101341	PEL22S/V	M20x1,5	12	0,35	M20x1,5	12/10	M10x1	25/17	
	101457	PEL22S/V	M20x1,5	12	0,35	M20x1,5	12/10	M8x1	25/-	
	101798	PEL22S/V	3/8"	-	0,35	3/8"	-	M10x1	25/-	
	101793	PEL22S/V	M20x1,5	12	0,90	M20x1,5	12/10	M8x1	45/20	
	101087	PEL22S/V	M20x1,5	12	0,35	M20x1,5	12/10	M9x1	25/17	
	106073	PEL22S/V	M20x1,5	12	0,35	M20x1,5	12/10	M8x1	35/17	
	101981	PEL22S/V	M20x1,5	12	0	M20x1,5	12/10	M9x1	34/26	
	2	101887	PEL22S/V	M20x1,5	12	0	M20x1,5	12/10	M9x1	
3	107200	PEL22S/V	M20x1,5	12	0	M20x1,5	12/10	M9x1	16/7	



## PEL 22S/O, output horizontal with safety

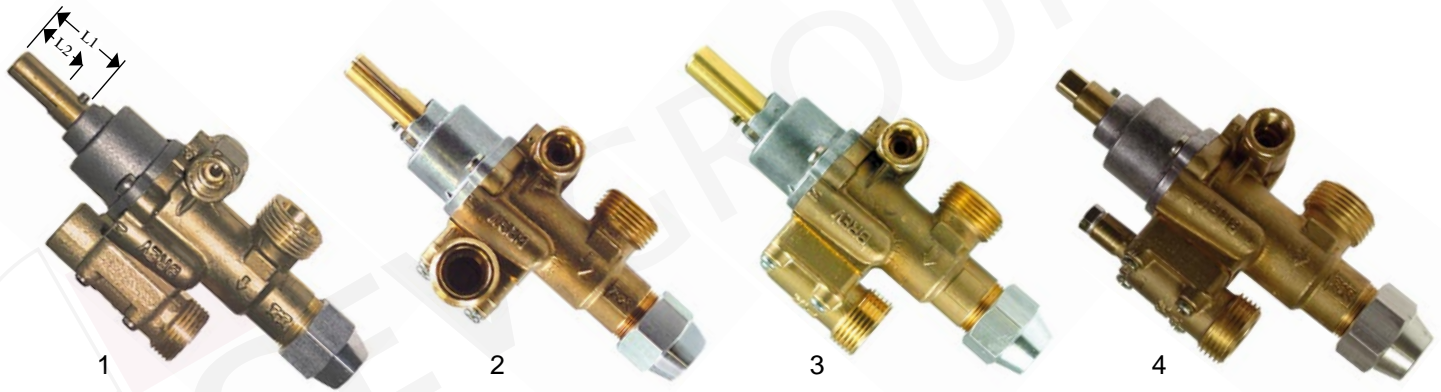

item	order no.	description	gas input	ø pipe input (mm)	ø bypass nozzle (mm)	gas outlet	ø pipe outlet (mm)	thermocouple connection	L1/L2 (mm)	spindle (mm)
	101086	PEL22S/O	M20x1,5	12	0,35	M20x1,5	12/10	M9x1	25/17	
	101510	PEL22S/O	M20x1,5	12	0	M20x1,5	12/10	M9x1	25/17	
	101089	PEL22S/O	M20x1,5	12	0,35	M20x1,5	12/10	M8x1	25/17	
	109510	PEL22S/O	M20x1,5	12	1,30	M20x1,5	12/10	M8x1	25/17	
1	109513	PEL22S/O	M20x1,5	12	1,10	M20x1,5	12/10	M8x1	25/17	
	101085	PEL22S/O	M20x1,5	12	0,35	M20x1,5	12/10	M8x1	28/13	
	101090	PEL22S/O	M20x1,5	12	0,35	M20x1,5	12/10	M8x1	28/13	
	106022	PEL22S/O	M20x1,5	12	0,35	M20x1,5	12/10	M8x1	45/20	
	106056	PEL22S/O	M20x1,5	12	0,35	M20x1,5	12/10	M10x1	45/20	
	101949	PEL22S/O	M20x1,5	12	0	M20x1,5	12/10	M9x1	25/17	
	101892	PEL22S/O	M20x1,5	12	0,35	M20x1,5	12/10	M9x1	25/17	
2	106023	PEL22S/O	M20x1,5	12	0	M20x1,5	12/10	M8x1	29/19,5	
3	101950	PEL22S/O	M20x1,5	12	0,35	M20x1,5	12/10	M9x1	25/17	
	107201	PEL22S/O	M20x1,5	12	0	M20x1,5	12/10	M9x1	16/7	
4	106159	PEL22S/O	M20x1,5	12	0	M20x1,5	12/10	M9x1	47/-	

## PEL 22 with safety and tube clamp

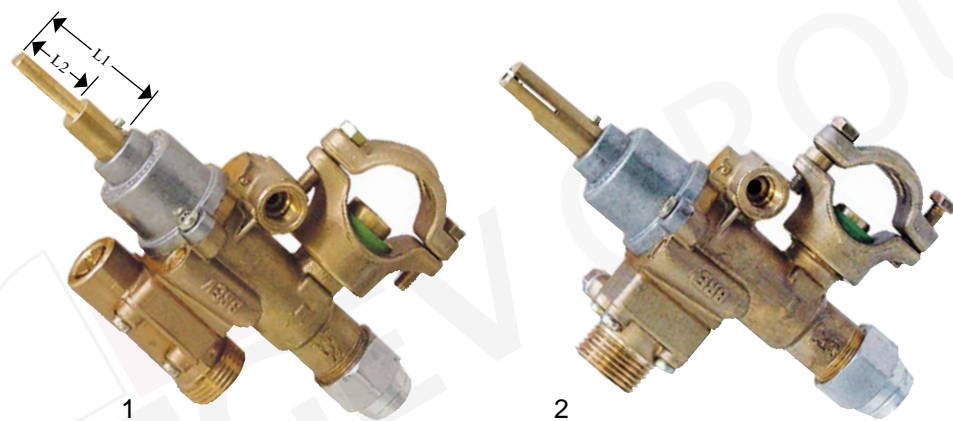

item	order no.	description	ø gas input (mm)	ø bypass nozzle (mm)	gas outlet	ø pipe outlet (mm)	thermocouple connection	L1/L2 (mm)	spindle (mm)
1	101626	PEL22S/O	27	0,35	M20x1,5	12/10	M8x1	35/21	
	101469	PEL22S/O	21	0,35	M20x1,5	12	M9x1	39/7	
	101489	PEL22S/O	27	0,35	M20x1,5	14	M8x1	39/7	
2	101661	PEL22S/V	21	0,35	M20x1,5	12/10	M8x1	28/13	

## PEL 23S with safety

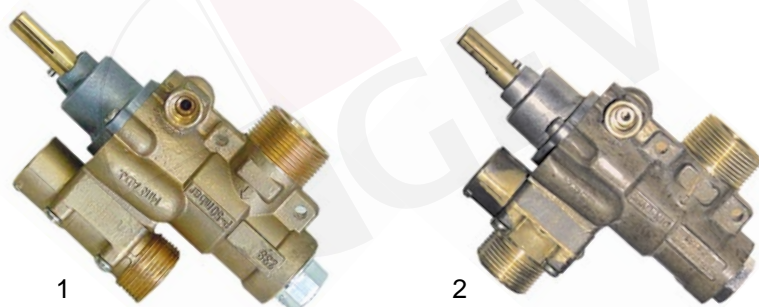

item	order no.	description	gas input	ø pipe input (mm)	ø bypass nozzle (mm)	gas outlet	ø pipe outlet (mm)	thermocouple connection	L1/L2 (mm)	spindle (mm)
1	101893	PEL23S/O	M28x1,5	20	0,35	M24x1,5	16/12	M9x1	25/17	
	106033	PEL23S/O	M28x1,5	20	0,35	M24x1,5	16/12	M10x1	25/17	
	101954	PEL23S/O	M28x1,5	20	1,70	M24x1,5	16/12	M10x1	25/17	
	101092	PEL23S/O	M28x1,5	20	0,35	M24x1,5	16/12	M10x1	25/17	
	101091	PEL23S/O	M28x1,5	20	0,35	M24x1,5	16/12	M9x1	35/19	
2	101953	PEL23S/V	M28x1,5	20	1,15	M24x1,5	16/12	M10x1	25/17	
	101093	PEL23S/V	M28x1,5	20	0,35	M24x1,5	16/12	M10x1	25/17	
	101630	PEL23S/V	1/2" ID	-	0,35	1/2" ET	-	M10x1	25/-	

## accessories and spare parts for PEL 20/21

### bypass nozzles



pos.	order no.	ø (mm)	pos.	order no.	ø (mm)	pos.	order no.	ø (mm)
1	100408	0,35	10	100555	0,80	18	100532	1,20
2	100553	0,40	11	100527	0,85	19	100394	1,25
3	100554	0,45	12	100528	0,90	20	100533	1,30
4	100526	0,50	13	100556	0,95	21	100549	1,35
5	100550	0,55	14	100529	1,00	22	100534	1,40
6	100551	0,60	15	100557	1,05	23	100558	1,55
7	100548	0,65	16	100530	1,10	24	100559	1,70
8	100552	0,70	17	100531	1,15	25	100547	1,75
9	100278	0,75						



item	order no.	description	thread	ø pipe (mm)
	101451	union nut	M16x1,5	8
1	101300	union nut	M16x1,5	10
	100943	union nut	M17x1	10
2	101450	olive	-	8
	101278	olive	-	10
3	106168	solder connection	-	10
4	100908	union screw	M10x1	4
	100909	union screw	M10x1	6
5	101246	olive	-	4
6	101286	olive	-	6
7	101880	gasket for pipe flange ø 21mm	-	-

### front parts

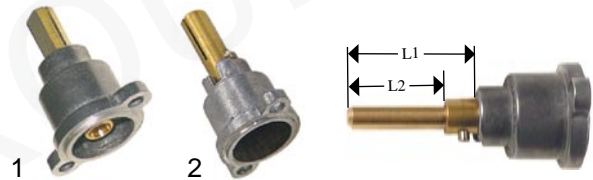

item	order no.	type	L1/L2 (mm)	spindle (mm)
1	101205	PEL 20	22/15	
	106156	PEL 20	39/15	
	101206	PEL 21	22/15	
	101875	PEL 21	32/25	
	106147	PEL 21	37/15	
2	101874	PEL 21	22/15	
	101803	PEL 21	30/23	
	101804	PEL 21	30/17,5	
	106149	PEL 21	45/19	
	106146	PEL 21	35/28	
	101808	PEL 21	31/15	



item	order no.	description	thread	item	order no.	description	thread
1	101230	magnetic nut	M8x1	1	101290	magnetic nut	M10x1
	101231	magnetic nut	M9x1	2	101060	magnetic shim	-

## accessories and spare parts for PEL 22

### bypass nozzles



pos.	order no.	ø (mm)	pos.	order no.	ø (mm)	pos.	order no.	ø (mm)
1	106191	0	8	100428	0,65	15	100407	1,00
2	100259	0,35	9	100429	070	16	100435	1,05
3	100281	0,40	10	100432	0,75	17	100436	1,10
4	100414	0,45	11	100409	0,80	18	100437	1,15
5	100390	0,50	12	100410	0,85	19	100438	1,20
6	100391	0,55	13	100433	0,90	20	100413	1,65
7	100392	0,60	14	100434	0,95	21	100776	1,75



item	order no.	description	thread	ø pipe (mm)
1	101240	gas connecting piece horizontal	M20x1,5	12/10
2	101241	gas connecting piece vertical	M20x1,5	12/10
3	101235	gas connecting piece horizontal	M20x1,5	12/10
4	101236	gas connecting piece vertical	M20x1,5	12/10
5	101365	gas connecting piece horizontal	M20x1,5	12
	101366	gas connecting piece horizontal	M20x1,5	14



item	order no.	description
1	101461	screw set
2	101460	o-ring
3	101331	adapter for flanged cable
4	101536	gasket for pipe flange ø 21mm
	106165	gasket for pipe flange ø 27mm

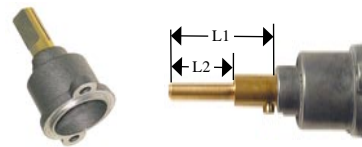

pos.	order no.	L1/L2 (mm)	spindle (mm)
1	101201	25/17	
2	101449	35/17	
3	101873	34/26	
4	101202	25/17	
5	101203	28/13	
6	101200	25/-	
7	106162	16/7	
8	106163	47/-	
9	101823	35/21	
10	106154	29/19,5	
11	101214	45/20	
12	101213	45/20	
13	106151	39/7	
14	106152	39/7	



pos.	order no.	description	thread	ø pipe (mm)
1	101250	union nut	M20x1,5	10
	101251	union nut	M20x1,5	12
	101427	union nut	M20x1,5	14
2	101249	olive	-	10
	101248	olive	-	12
3	101428	olive	-	14
	101531	solder connection	-	12
5	100908	union screw	M10x1	4
	100909	union screw	M10x1	6
6	101246	olive	-	4
7	101286	olive	-	6



item	order no.	description	thread	item	order no.	description	thread
1	101230	magnetic nut	M8x1	1	101290	magnetic nut	M10x1
	101231	magnetic nut	M9x1	2	101058	magnetic shim	-

## accessories and spare parts for PEL 23

### bypass nozzles



pos.	order no.	ø (mm)	pos.	order no.	ø (mm)	pos.	order no.	ø (mm)
1	106201	0	12	100627	1,00	23	100699	1,55
2	100455	0,35	13	100628	1,05	24	100250	1,60
3	100448	0,50	14	100649	1,10	25	100251	1,65
4	100458	0,60	15	100655	1,15	26	100263	1,70
5	100459	0,65	16	100659	1,20	27	100264	1,75
6	100493	0,70	17	100664	1,25	28	100265	1,80
7	100494	0,75	18	100666	1,30	29	100266	1,85
8	100497	0,80	19	100667	1,35	30	100267	1,90
9	100546	0,85	20	100674	1,40	31	100268	1,95
10	100597	0,90	21	100677	1,45	32	100273	2,00
11	100598	0,95	22	100679	1,50			



item	order no.	description	thread	ø pipe (mm)
1	101252	union nut	M24x1,5	12
	101253	union nut	M24x1,5	16
	101254	union nut	M28x1,5	20
2	101255	locking ring	-	12
3	101256	locking ring	-	16
	101257	locking ring	-	20
4	100908	screw	M10x1	4
	100909	screw	M10x1	6
5	101246	locking ring	-	4
6	101286	locking ring	-	6

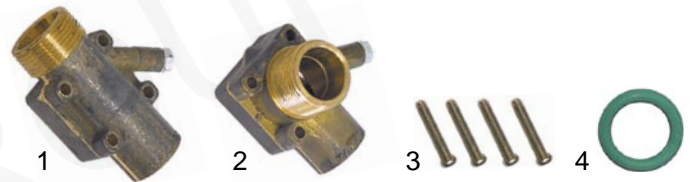

item	order no.	description	thread	ø pipe (mm)
1	101244	gas connecting piece horizontal	M24x1,5	16/12
2	101245	gas connecting piece vertical	M24x1,5	16/12
3	101463	screw set	-	-
4	101462	o-ring	-	-

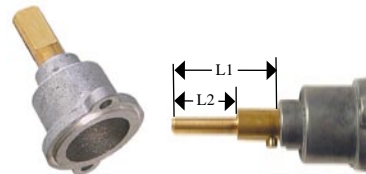

pos.	order no.	L1/L2 (mm)	spindle (mm)
1	101204	25/17	
2	101336	35/19	
3	106166	25/17	
4	102767	25/-	



pos.	order no.	description	thread	pos.	order no.	description	thread
1	101059	magnetic shim	M10x1	2	101045	magnetic shim	M9x1

## gas taps EGA

EGA 31849 with pipe outlet

EGA 31248 with pipe and nozzle orifice

EGA 30750 with pipe outlet



item	order no.	substitute no.	type EGA	description	gas input	ø nozzles (mm)			mixing pipe connection	pipe outlet	thermocouple connection	front fixing	L1/L2 (mm)	spindle (mm)
						external nozzle	internal nozzle	bypass nozzle						
1	nla*	101629	31849	gas tap with pipe outlet	M12x1 (8mm)	-	-	0,55	-	M12x1 (8mm)	M8x1	M12x1	29,5/21	
	nla*	101638	31849		M12x1 (8mm)	-	-	1,00	-	M12x1 (8mm)	M8x1	M12x1	29,5/21	
2	nla*	101074	31248	gas tap	M12x1 (8mm)	-	-	0,35	-	M12x1 (8mm)	M8x1	M12x1	29,5/21	
	nla*	101072	31248		M12x1 (8mm)	-	-	0,35	-	M12x1 (8mm)	M8x1	M12x1	29,5/13,5	
3	nla*	101193	31248	gas tap	M12x1 (8mm)	-	-	0,35	M17x1	-	M8x1	M12x1	23/13,5	
	nla*	101073	31248		M12x1 (8mm)	-	-	0,35	M17x1	-	M8x1	M12x1	23/13,5	
	nla*	106034	31248		M12x1 (8mm)	-	-	0,35	M17x1	-	M8x1	M12x1	29,5/13,5	
	nla*	106174	31248		M12x1 (8mm)	-	-	0,35	M17x1	-	M8x1	M12x1	23/13,5	
4	nla*	101194	31248	gas tap with nozzle outlet, with nozzles	M12x1 (8mm)	-	-	0,35	M17x1	-	M8x1	M12x1	17/9	
	nla*	101635	31248		M12x1 (8mm)	-	-	0,55	M17x1	-	M8x1	M12x1	37/17	
	nla*	101374	31248		M12x1 (8mm)	0,85	-	0,50	M17x1	-	M8x1	M12x1	29,5/21	
	nla*	101198	31248		M12x1 (8mm)	2,00	0,70	0,35	M17x1	-	M8x1	M12x1	29,5/21	
5	nla*	101381	31248	gas tap with pipe outlet	M12x1 (8mm)	0,85	-	0,50	M17x1	-	M8x1	M12x1	29,5/21	
	nla*	101631	31248		M12x1 (8mm)	2,20	1,20	0,55	M17x1	-	M8x1	M12x1	37/17	
	nla*	101632	31248		M12x1 (8mm)	2,20	1,40	0,70	M17x1	-	M8x1	M12x1	37/17	
5	101473	30750	gas tap with pipe outlet	M12x1 (8mm)	-	-	0,50	-	M12x1 ID (8mm)	M8x1	M12x1	22/19		

\*no longer available

**EGA 26400 with pipe outlet, without ignition flame connection**  
**EGA 26440 with pipe outlet, with ignition flame connection**



item	order no.	substitute no.	type EGA	gas input	ø gas input (mm)	ø bypass nozzle (mm)	gas outlet	ø pipe outlet (mm)	thermocouple connection	L1/L2 (mm)	spindle (mm)	
1	nla*	101603	26400R	M15x1	10	0,35	M17x1	10	M8x1	31/23		
	nla*	101608	26400R	M15x1	10	0,35	M17x1	10	M8x1	34/15		
	nla*	101616	26400R	M15x1	10	0,35	M17x1	10	M8x1	31/15		
	nla*	-	26400R	M15x1	10	0,35	M17x1	10	M8x1			
2	nla*	101648**	26400RD	M15x1	10	0,35	M17x1	10	M8x1	31/23		
	nla*	101605	26440R	M15x1	10	0,35	M17x1	10	M8x1	31/23		
	nla*	101658	26440R	M15x1	10	0,60	M17x1	10	M8x1	31/23		
	nla*	101612	26440R	M15x1	10	0,35	M17x1	10	M8x1	22/15		
	nla*	101614	26440R	M15x1	10	0,35	M17x1	10	M8x1	22/15		
	nla*	101640	26440R	M15x1	10	0,35	M17x1	10	M8x1	31/23		
	3	nla*	101618	26440R	M15x1	10	0,35	M17x1	10	M10x1	34/15	
		nla*	101643	26440R	M15x1	10	0,45	M17x1	10	M10x1	34/15	
		nla*	101664	26440R	M15x1	10	0,55	M17x1	10	M10x1	34/15	
		nla*	101644	26440R	M15x1	10	0,65	M17x1	10	M10x1	34/15	
nla*		101650	26440R	M15x1	10	0,35	M17x1	10	M8x1	31/23		
nla*		101651	26440R	M15x1	10	1,10	M17x1	10	M8x1	31/23		
nla*		101652	26440R	M15x1	10	1,25	M17x1	10	M8x1	31/23		
nla*		101681	26440R	M15x1	10	0,35	M17x1	10	M8x1	31/15		
4	nla*	101646**	26440RD	M15x1	10	0,35	M17x1	10	M8x1	31/23		

\*no longer available

\*\*with throttle for main gas line

**EGA 26400 with nozzle outlet, without ignition flame connection**

**EGA 26440 with nozzle outlet, with ignition flame connection**



item	order no.	substitute no.	type EGA	gas input	ø pipe input (mm)	ø nozzles (mm)			mixing pipe connection	thermocouple connection	L1/L2 (mm)	spindle (mm)
						external nozzle	internal nozzle	bypass nozzle				
1	nla*	101604	26400D	M15x1	10	-	-	0,35	M17x1	M8x1	22/15	
	nla*	101607	26400D	M15x1	10	-	-	0,35	M17x1	M8x1	31/23	
	nla*	101617	26400D	M15x1	10	-	-	0,35	M17x1	M8x1	24/15	
	nla*	101797	26400D	M15x1	8	-	-	0,35	M17x1	M8x1	24/15	
2	nla*	101609	26400D	M15x1	10	2,20	0,60	0,35	M17x1	M8x1	24/15	
	nla*	101667	26400D	M15x1	8	2,20	0,60	0,35	M17x1	M8x1	24/15	
	nla*	101675	26400D	M15x1	8	2,60	0,95	0,70	M17x1	M8x1	24/15	
3	nla*	101619	26440D	M15x1	10	-	-	0,35	M17x1	M8x1	31/23	
	nla*	101613	26440D	M15x1	10	-	-	0,35	M17x1	M10x1	34/15	
	nla*	101615	26440D	M15x1	10	-	-	0,35	M17x1	M8x1	31/15	
	nla*	101606	26440D	M15x1	10	-	-	0,35	M17x1	M8x1	31/23	
	nla*	101663	26440D	M15x1	10	2,05	1,85	0,35	M17x1	M8x1	31/23	
4	nla*	101983	26440D	M15x1	10	1,35	0,66	0,35	M17x1	M10x1	34/15	
	nla*	101668	26440D	M15x1	10	1,35	1,20	0,35	M17x1	M10x1	34/15	
	nla*	101642	26440D	M15x1	10	1,55	0,80	0,45	M17x1	M10x1	34/15	
	nla*	101767	26440D	M15x1	10	1,55	1,40	0,45	M17x1	M10x1	34/15	
	nla*	101731	26440D	M15x1	10	2,05	1,05	0,55	M17x1	M10x1	34/15	
	nla*	101641	26440D	M15x1	10	2,05	1,90	0,55	M17x1	M10x1	34/15	
nla*	101633	26440D	M15x1	10	1,40	0,80	0,35	M17x1	M8x1	31/23		
5	nla*	101634	26440D	M15x1	10	1,85	1,05	0,50	M17x1	M8x1	31/23	
	nla*	101647	26440DF	M15x1	10	-	-	0,35	M17x1	M8x1	31/23	
	nla*	101653	26440DF	M15x1	10	-	1,40	0,85	M17x1	M8x1	31/23	
	nla*	101654	26440DF	M15x1	10	-	1,80	1,10	M17x1	M8x1	31/23	
nla*	101655	26440DF	M15x1	10	-	2,05	1,25	M17x1	M8x1	31/23		

\*no longer available



## EGA 24197 with pipe outlet EGA 24197 with nozzle outlet

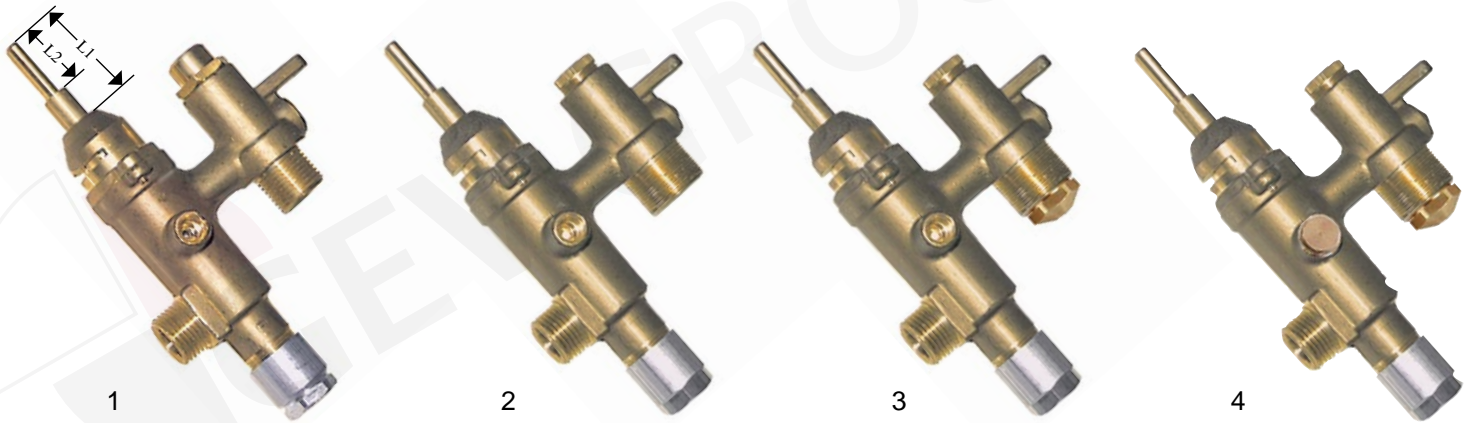

item	order no.	substitute no.	description	gas input	ø nozzles (mm)			gas outlet	mixing pipe connection	thermocouple connection	L1/L2 (mm)	spindle (mm)
					external nozzle	internal nozzle	bypass nozzle					
1	nla*	101620	24197R	-	-	0,35	-	-	M8x1	35/21		
	nla*	101621	24197R	-	-	0,35	-	-	M8x1	34/15		
	nla*	101636	24197R	-	-	0,35	M18x1,5 ø 12mm	-	M8x1	34/15		
	nla*	101666	24197R	-	-	0,35	-	-	M8x1	34/15		
	nla*	101657	24197RD	-	-	0,5	-	-	M8x1	35/21		
	nla*	101622	24197D	-	-	0,35	-	M22x1,5	M8x1	35/21		
	nla*	101624	24197D	-	-	0,35	-	M22x1,5	M8x1	34/15		
	nla*	101625	24197D	M18x1,5 ø 12mm	-	0,35	-	M22x1,5	M8x1	34/15		
	nla*	101623	24197D	-	-	0,35	-	M22x1,5	M8x1	34/15		
	nla*	101649	24197D	-	-	0,40	-	M22x1,5	M8x1	34/15		
2	nla*	101659	24197D	-	-	0,35	-	M22x1,5	M8x1	34/15		
	nla*	101656	24197D	-	-	1,65	-	M22x1,5	M8x1	35/21		
	nla*	101662	24197D	-	1,00	0,35	-	M22x1,5	M8x1	34/15		
	nla*	101665	24197D	-	0,80	0,35	-	M22x1,5	M8x1	34/15		
	nla*	101764	24197D	-	1,00	0,35	-	M22x1,5	M8x1	34/15		
3	nla*	106040**	24197D	-	-	0,35	-	M22x1,5	M8x1	34/15		
	nla*	106041**	24197D	-	-	0,35	-	M22x1,5	M8x1	34/15		

\*no longer available

\*\*output for ignition flame closed

## accessories and spare parts for EGA 26400/26440

### bypass nozzles



pos.	order no.	ø (mm)	pos.	order no.	ø (mm)	pos.	order no.	ø (mm)
1	nla*	0,23	9	100354	0,50	17	100346	0,85
2	nla*	0,30	10	100355	0,52	20	100347	0,90
3	nla*	0,33	11	100356	0,55	21	100362	1,00
4	100364	0,35	12	100368	0,60	22	100348	1,10
5	nla*	0,37	13	100361	0,65	23	100359	1,20
6	100353	0,40	14	100357	0,70	24	100363	1,50
7	100366	0,44	15	100358	0,75	25	100349	1,80
8	100367	0,47	16	100328	0,80			

\*no longer available



item	order no.	description	thread	ø pipe (mm)
	100941	union nut	M15x1	8
1	100942	union nut	M15x1	10
	100943	union nut	M17x1	10
	101450	olive	-	8
2	101278	olive	-	10
3	101285	union screw	M8x1	4
4	101284	olive	-	4



item	order no.	description	thread	item	order no.	description	thread
1	100926	centring ring	M17x1	3	101230	magnetic nut	M8x1
2	101394	nut	M17x1	3	101233	magnetic nut	M10x1



item	order no.	description	type gas tap	item	order no.	description	type gas tap
1	101051	magnetic shim	31849 31248 30750	2	101060	magnetic shim	26400 26440

### external nozzles M12x1



pos.	order no.	ø (mm)	pos.	order no.	ø (mm)	pos.	order no.	ø (mm)
1	100974	0,80	18	100287	1,45	35	100309	2,30
2	100279	0,82	19	100700	1,50	36	100668	2,35
3	100249	0,85	20	100301	1,55	37	100294	2,40
4	100283	0,90	21	100665	1,60	38	100749	2,45
5	100280	0,93	22	100239	1,65	39	100326	2,50
6	100282	0,95	23	100288	1,70	40	100416	2,55
7	100284	1,00	24	100878	1,75	41	100304	2,60
8	100662	1,05	25	100289	1,80	42	100295	2,70
9	100285	1,10	26	100302	1,85	43	100305	3,00
10	100243	1,12	27	100290	1,90	44	100752	3,20
11	100663	1,15	28	100740	1,95	45	100296	3,30
12	100306	1,20	29	100291	2,00	46	100297	3,45
13	100975	1,25	30	100303	2,05	47	100298	3,50
14	100286	1,30	31	100292	2,10	48	100299	3,70
15	100300	1,35	32	100744	2,12	49	100763	3,80
16	100669	1,37	33	100308	2,15	50	102794	3,85
17	100307	1,40	34	100293	2,20	51	100762	4,10

### internal nozzles



pos.	order no.	ø (mm)	pos.	order no.	ø (mm)	pos.	order no.	ø (mm)
1	100657	0,60	8	100315	0,95	15	100316	1,70
2	100310	0,66	9	100312	1,05	16	100951	1,75
3	100319	0,75	10	100313	1,20	17	100244	1,85
4	100393	0,78	11	100238	1,35	18	100314	1,90
5	100311	0,80	12	100322	1,40	19	100274	2,00
6	100624	0,85	13	100773	1,55	20	100317	2,20
7	100321	0,90	14	100318	1,60	21	100678	2,50

### internal nozzles for gas tap with fixed external nozzle



pos.	order no.	ø (mm)	pos.	order no.	ø (mm)	pos.	order no.	ø (mm)
1	100395	1,40	2	100396	1,80	3	100397	2,05

## accessories and spare parts for EGA 24197

### bypass nozzles



pos.	order no.	ø (mm)	pos.	order no.	ø (mm)	pos.	order no.	ø (mm)
1	nla*	0,23	9	100354	0,50	17	100346	0,85
2	nla*	0,30	10	100355	0,52	20	100347	0,90
3	nla*	0,33	11	100356	0,55	21	100362	1,00
4	100364	0,35	12	100368	0,60	22	100348	1,10
5	nla*	0,37	13	100361	0,65	23	100359	1,20
6	100353	0,40	14	100357	0,70	24	100363	1,50
7	100366	0,44	15	100358	0,75	25	100349	1,80
8	100367	0,47	16	100328	0,80			

\*no longer available

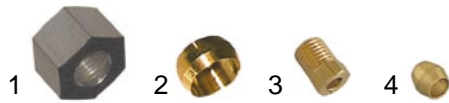

item	order no.	description	thread	ø pipe (mm)
1	100944	union nut	M18x1,5	12
2	101273	olive	-	12
3	101285	union screw	M8x1	4
4	101284	locking ring	-	4



item	order no.	description	thread
1	101230	magnetic nut	M8x1
	101233	magnetic nut	M10x1
2	101058	magnetic shim	

### external nozzles M15x1



pos.	order no.	ø (mm)	pos.	order no.	ø (mm)	pos.	order no.	ø (mm)
1	100451	1,50	7	100456	2,50	13	100406	3,70
2	100337	1,60	8	100457	2,60	14	100332	3,80
3	100453	2,00	9	100331	2,70	15	100335	3,90
4	100338	2,10	10	100698	3,00	16	100336	4,00
5	100330	2,20	11	100339	3,40	17	100329	4,40
6	100333	2,30	12	100334	3,50			

### internal nozzles



pos.	order no.	ø (mm)	pos.	order no.	ø (mm)	pos.	order no.	ø (mm)
1	100377	0,65	8	100341	1,15	14	100658	1,80
2	100496	0,73	9	100344	1,20	15	100323	1,85
3	100378	0,77	10	100647	1,30	16	100345	1,90
4	100492	0,80	11	100648	1,35	17	100324	2,10
5	100340	0,85	12	100342	1,40	18	100327	2,35
6	100343	1,00	13	100656	1,60	19	100398	2,50
7	100495	1,05						

## gas taps EGA/PEL 20/21

PEL 20 with pipe outlet, without ignition flame connection









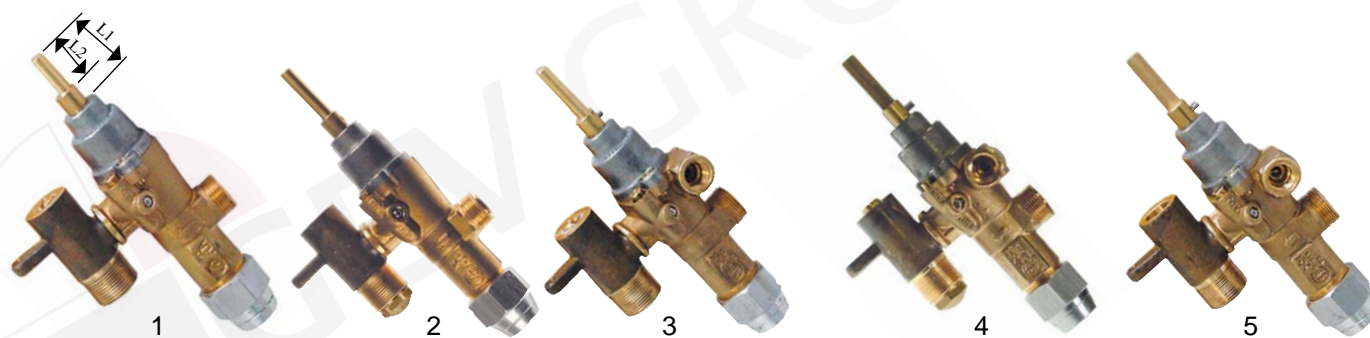





PEL 21 with pipe outlet, with ignition flame connection



item	order no.	type	gas input	ø pipe (mm)	ø bypass nozzle (mm)	gas outlet	ø pipe outlet (mm)	thermocouple connection	L1/L2 (mm)	spindle (mm)
	101608	PEL20R	M15x1	10	0,35	M17x1	10	M8x1	34/15	
1	101616	PEL20R	M15x1	10	0,35	M17x1	10	M8x1	31/15	
	101603	PEL20R	M15x1	10	0,35	M17x1	10	M8x1	31/23	
2	101648*	PEL20RD	M15x1	10	0,35	M17x1	10	M8x1	31/23	
	101605	PEL21R	M15x1	10	0,35	M17x1	10	M8x1	31/23	
	101658	PEL21R	M15x1	10	0,60	M17x1	10	M8x1	31/23	
	101612	PEL21R	M15x1	10	0,35	M17x1	10	M8x1	22/15	
	101614	PEL21R	M15x1	10	0,35	M17x1	10	M8x1	22/15	
	101618	PEL21R	M15x1	10	0,35	M17x1	10	M10x1		
3	101643	PEL21R	M15x1	10	0,45	M17x1	10	M10x1	34/15	
	101664	PEL21R	M15x1	10	0,55	M17x1	10	M10x1	34/15	
	101644	PEL21R	M15x1	10	0,65	M17x1	10	M10x1	34/15	
	101640	PEL21R	M15x1	10	0,35	M17x1	10	M8x1	31/23	
	101650	PEL21R	M15x1	10	0,35	M17x1	10	M8x1	31/23	
	101651	PEL21R	M15x1	10	1,10	M17x1	10	M8x1	31/23	
	101652	PEL21R	M15x1	10	1,25	M17x1	10	M8x1	31/23	
	101681	PEL21R	M15x1	10	0,35	M17x1	10	M8x1	31/15	
4	101646*	PEL21RD	M15x1	10	0,35	M17x1	10	M8x1	31/23	

\*with throttle for main gas line

**PEL 20 with nozzle outlet, without ignition flame connection**
**PEL 21 with nozzle outlet, with ignition flame connection**

item	order no.	type	gas input	ø pipe (mm)	ø nozzles (mm)			mixing pipe connection	thermocouple connection	L1/L2 (mm)	spindle (mm)
					external nozzle	internal nozzle	bypass nozzle				
1	101604	PEL20D	M15x1	10	-	-	0,35	M17x1	M8x1	22/15	
	101607	PEL20D	M15x1	10	-	-	0,35	M17x1	M8x1	31/23	
	101617	PEL20D	M15x1	10	-	-	0,35	M17x1	M8x1	24/15	
	101797	PEL20D	M15x1	8	-	-	0,35	M17x1	M8x1	24/15	
2	101609	PEL20D	M15x1	10	2,20	0,60	0,35	M17x1	M8x1	24/15	
	101667	PEL20D	M15x1	8	2,20	0,60	0,35	M17x1	M8x1	24/15	
	101675	PEL20D	M15x1	8	2,60	0,95	0,70	M17x1	M8x1	24/15	
3	101606	PEL21D	M15x1	10	-	-	0,35	M17x1	M8x1	31/23	
	101619	PEL21D	M15x1	10	-	-	0,35	M17x1	M8x1	31/23	
	101613	PEL21D	M15x1	10	-	-	0,35	M17x1	M10x1	34/15	
	101615	PEL21D	M15x1	10	-	-	0,35	M17x1	M8x1	31/15	
4	101633	PEL21D	M15x1	10	1,40	0,80	0,35	M17x1	M8x1	31/23	
	101634	PEL21D	M15x1	10	1,85	1,05	0,50	M17x1	M8x1	31/23	
	101983	PEL21D	M15x1	10	1,35	0,66	0,35	M17x1	M10x1	34/15	
	101668	PEL21D	M15x1	10	1,35	1,20	0,35	M17x1	M10x1	34/15	
	101642	PEL21D	M15x1	10	1,55	0,80	0,45	M17x1	M10x1	34/15	
	101767	PEL21D	M15x1	10	1,55	1,40	0,45	M17x1	M10x1	34/15	
	101731	PEL21D	M15x1	10	2,05	1,05	0,55	M17x1	M10x1	34/15	
	101641	PEL21D	M15x1	10	2,05	1,90	0,55	M17x1	M10x1	34/15	
5	101663	PEL21D	M15x1	10	2,05	1,85	0,35	M17x1	M8x1	31/23	
	101647	PEL21DF	M15x1	10	-	-	0,35	M17x1	M8x1	31/23	
	101653	PEL21DF	M15x1	10	-	1,40	0,85	M17x1	M8x1	31/23	
	101654	PEL21DF	M15x1	10	-	1,80	1,10	M17x1	M8x1	31/23	
	101655	PEL21DF	M15x1	10	-	2,05	1,25	M17x1	M8x1	31/23	

## gas taps EGA/PEL 22

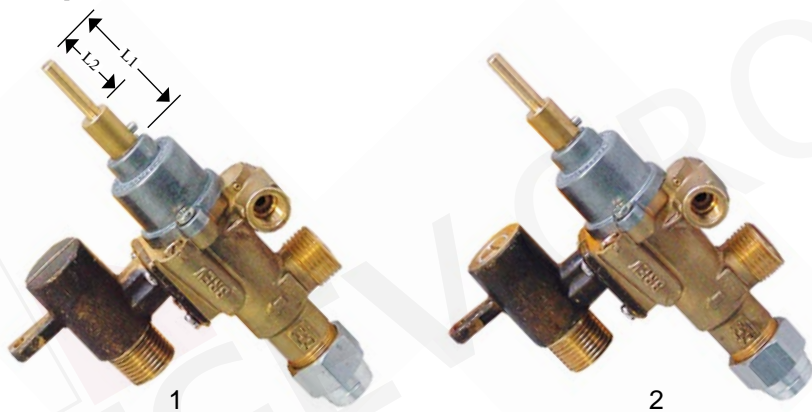

item	order no.	type	gas input	ø pipe input (mm)	ø bypass nozzle (mm)	gas outlet	ø pipe outlet (mm)	thermocouple connection	L1/L2 (mm)	spindle (mm)
	101621	PEL22R	M18x1,5	12	0,35	M18x1,5	12	M8x1	34/15	
	101636	PEL22R	M18x1,5	12	0,35	M18x1,5	12	M8x1	34/15	
1	101666	PEL22R	M18x1,5	12	0,35	M18x1,5	12	M8x1	34/15	
	101620	PEL22R	M18x1,5	12	0,35	M18x1,5	12	M8x1	35/21	
2	101657	PEL22RD	M18x1,5	12	0,5	M18x1,5	12	M8x1	35/21	



item	order no.	type	gas input	ø pipe input (mm)	external nozzle	ø nozzles (mm) internal nozzle	bypass nozzle	mixing pipe connection	thermocouple connection	L1/L2 (mm)	spindle (mm)
	106040*	PEL22D	M18x1,5	12	-	-	0,35	M22x1,5	M8x1	34/15	
1	106041*	PEL22D	M18x1,5	12	-	-	0,35	M22x1,5	M8x1	34/15	
	101625	PEL22D	M18x1,5	12	-	-	0,35	M22x1,5	M8x1	34/15	
	101622	PEL22D	M18x1,5	12	-	-	0,35	M22x1,5	M8x1	35/21	
2	101624	PEL22D	M18x1,5	12	-	-	0,35	M22x1,5	M8x1	34/15	
	101623	PEL22D	M18x1,5	12	-	-	0,35	M22x1,5	M8x1	34/15	
	101649	PEL22D	M18x1,5	12	2,60	1,35	0,40	M22x1,5	M8x1	34/15	
	101659	PEL22D	M18x1,5	12	2,20	1,15	0,35	M22x1,5	M8x1	34/15	
	101656	PEL22D	M18x1,5	12	4,40	2,50	1,65	M22x1,5	M8x1	35/21	
3	101662	PEL22D	M18x1,5	12	2,10	1,00	0,35	M22x1,5	M8x1	34/15	
	101665	PEL22D	M18x1,5	12	1,60	0,80	0,35	M22x1,5	M8x1	34/15	
	101764	PEL22D	M18x1,5	12	1,60	1,00	0,35	M22x1,5	M8x1	34/15	

\*ignition line output closed

## accessories and spare parts for EGA/PEL 20/21



item	order no.	description	thread	ø pipe (mm)
	100941	union nut	M15x1	8
1	100942	union nut	M15x1	10
	100943	union nut	M17x1	10
	101450	olive	-	8
2	101278	olive	-	10
3	100926	centring ring	M17x1	
4	101394	nut	M17x1	
	100908	screw	M10x1	4
5	100909	screw	M10x1	6
6	101246	olive	-	4
7	101286	olive	-	6



item	order no.	description	for thermocouple
	101230	magnetic nut	M8x1
1	101231	magnetic nut	M9x1
	101290	magnetic nut	M10x1
2	101060	magnetic shim	-

## front parts

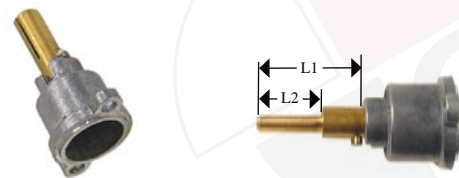

pos.	order no.	type	L1/L2 (mm)	spindle (mm)
	106167	PEL 20	22/15	
1	101805	PEL 21	22/15	
	101801	PEL 20	31/23	
	101803	PEL 21	31/23	
2	101809	PEL 20	24/15	
	101810	PEL 20	34/15	
3	101806	PEL 21	34/15	
4	101802	PEL 21	31/23	
	101206	PEL 21	22/15	
5	101807	PEL 21	31/23	
	101808	PEL 21	31/15	
6	101811	PEL 20	31/15	

## bypass nozzles PEL 20/21



pos.	order no.	ø (mm)	pos.	order no.	ø (mm)	pos.	order no.	ø (mm)
1	100408	0,35	10	100555	0,80	18	100532	1,20
2	100553	0,40	11	100527	0,85	19	100394	1,25
3	100554	0,45	12	100528	0,90	20	100533	1,30
4	100526	0,50	13	100556	0,95	21	100549	1,35
5	100550	0,55	14	100529	1,00	22	100534	1,40
6	100551	0,60	15	100557	1,05	23	100558	1,55
7	100548	0,65	16	100530	1,10	24	100559	1,70
8	100552	0,70	17	100531	1,15	25	100547	1,75
9	100278	0,75						

## external nozzles M12x1



pos.	order no.	ø (mm)	pos.	order no.	ø (mm)	pos.	order no.	ø (mm)
1	100974	0,80	18	100287	1,45	35	100309	2,30
2	100279	0,82	19	100700	1,50	36	100668	2,35
3	100249	0,85	20	100301	1,55	37	100294	2,40
4	100283	0,90	21	100665	1,60	38	100749	2,45
5	100280	0,93	22	100239	1,65	39	100326	2,50
6	100282	0,95	23	100288	1,70	40	100416	2,55
7	100284	1,00	24	100878	1,75	41	100304	2,60
8	100662	1,05	25	100289	1,80	42	100295	2,70
9	100285	1,10	26	100302	1,85	43	100305	3,00
10	100243	1,12	27	100290	1,90	44	100752	3,20
11	100663	1,15	28	100740	1,95	45	100296	3,30
12	100306	1,20	29	100291	2,00	46	100297	3,45
13	100975	1,25	30	100303	2,05	47	100298	3,50
14	100286	1,30	31	100292	2,10	48	100299	3,70
15	100300	1,35	32	100744	2,12	49	100763	3,80
16	100669	1,37	33	100308	2,15	50	102794	3,85
17	100307	1,40	34	100293	2,20	51	100762	4,10

## internal nozzles



pos.	order no.	ø (mm)	pos.	order no.	ø (mm)	pos.	order no.	ø (mm)
1	100657	0,60	8	100315	0,95	15	100316	1,70
2	100310	0,66	9	100312	1,05	16	100951	1,75
3	100319	0,75	10	100313	1,20	17	100244	1,85
4	100393	0,78	11	100238	1,35	18	100314	1,90
5	100311	0,80	12	100322	1,40	19	100274	2,00
6	100624	0,85	13	100773	1,55	20	100317	2,20
7	100321	0,90	14	100318	1,60	21	100678	2,50

## internal nozzles for gas tap with fixed external nozzle



pos.	order no.	ø (mm)	pos.	order no.	ø (mm)	pos.	order no.	ø (mm)
1	100395	1,40	2	100396	1,80	3	100397	2,05

## accessories and spare parts for EGA/PEL22



item	order no.	description	thread	ø pipe (mm)
1	100944	union nut	M18x1,5	12
2	101273	olive	-	12
3	100908	screw	M10x1	4
4	100909	screw	M10x1	6
5	101246	locking ring	-	4
6	101286	locking ring	-	6



item	order no.	description	for thermocouple
	101230	magnetic nut	M8x1
1	101231	magnetic nut	M9x1
	101290	magnetic nut	M10x1
2	101058	magnetic shim	-

### front parts

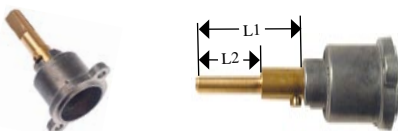

pos.	order no.	L1/L2 (mm)	spindle (mm)
1	101823	35/21	
2	101820	34/15	
3	101821	34/15	
4	106170	34/15	
5	101822	34/15	
6	106171	34/15	

## gas taps JUNKERS

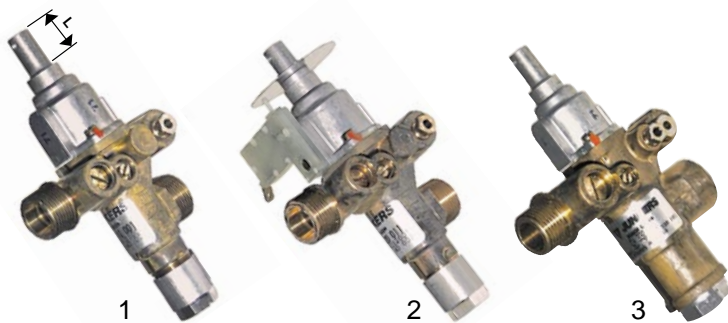

item	order no.	substitute	description	gas input	gas outlet	thermocouple connection	L (mm)	spindle (mm)
1	nla*	101457	CH110	M20x1,5	M20x1,5	M8x1	20,7	
2	nla*	101457	CH120	M20x1,5	M20x1,5	M8x1	20,7	
	nla*	101798	CH140	3/8"	3/8"	M8x1	20,7	
3	nla*	101630	CH330	1/2" I	1/2" A	M10x1	20,7	

\*no longer available

### bypass nozzles



pos.	order no.	ø (mm)	pos.	order no.	ø (mm)	pos.	order no.	ø (mm)
1	100259	0,35	8	100429	0,70	15	100435	1,05
2	100281	0,40	9	100432	0,75	16	100436	1,10
3	100414	0,45	10	100409	0,80	17	100437	1,15
4	100390	0,50	11	100410	0,85	18	100438	1,20
5	100391	0,55	12	100433	0,90	19	100413	1,65
6	100392	0,60	13	100434	0,95	20	100776	1,75
7	100428	0,65	14	100407	1,00			

### external nozzles



pos.	order no.	ø (mm)	pos.	order no.	ø (mm)	pos.	order no.	ø (mm)
1	100451	1,50	7	100456	2,50	13	100406	3,70
2	100337	1,60	8	100457	2,60	14	100332	3,80
3	100453	2,00	9	100331	2,70	15	100335	3,90
4	100338	2,10	10	100698	3,00	16	100336	4,00
5	100330	2,20	11	100339	3,40	17	100329	4,40
6	100333	2,30	12	100334	3,50			

### internal nozzles



pos.	order no.	ø (mm)	pos.	order no.	ø (mm)	pos.	order no.	ø (mm)
1	100377	0,65	8	100341	1,15	14	100658	1,80
2	100496	0,73	9	100344	1,20	15	100323	1,85
3	100378	0,77	10	100647	1,30	16	100345	1,90
4	100492	0,80	11	100648	1,35	17	100324	2,10
5	100340	0,85	12	100342	1,40	18	100327	2,35
6	100343	1,00	13	100656	1,60	19	100398	2,50
7	100495	1,05						





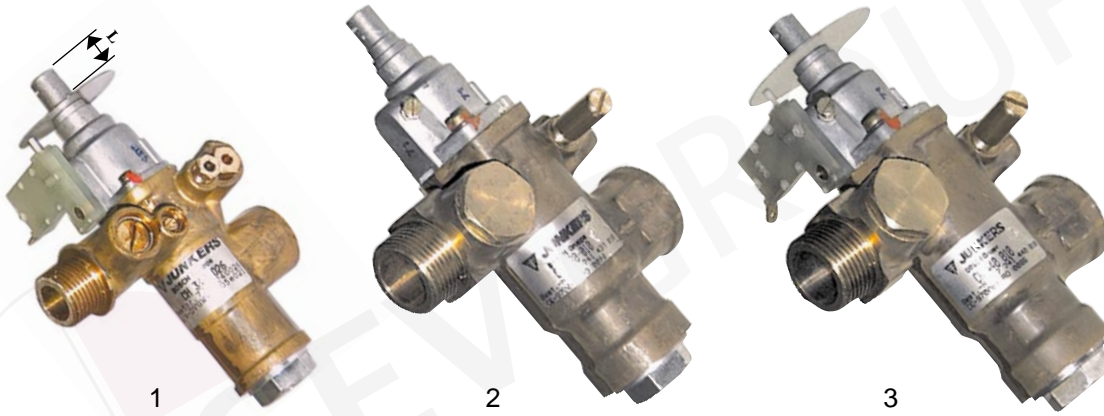

item	order no.	substitute no.	description	gas input	gas outlet	thermocouple connection	L (mm)	spindle (mm)
1	nla*	101630	CH340	1/2" ID	1/2" ET	M10x1	20,7	
2	nla*	-	CH430	3/4" ID	3/4" ET	M10x1	20,7	
3	nla*	-	CH440	3/4" ID	3/4" ET	M10x1	20,7	

\*no longer available

## gas taps PEL, alternatively as substitute for JUNKERS

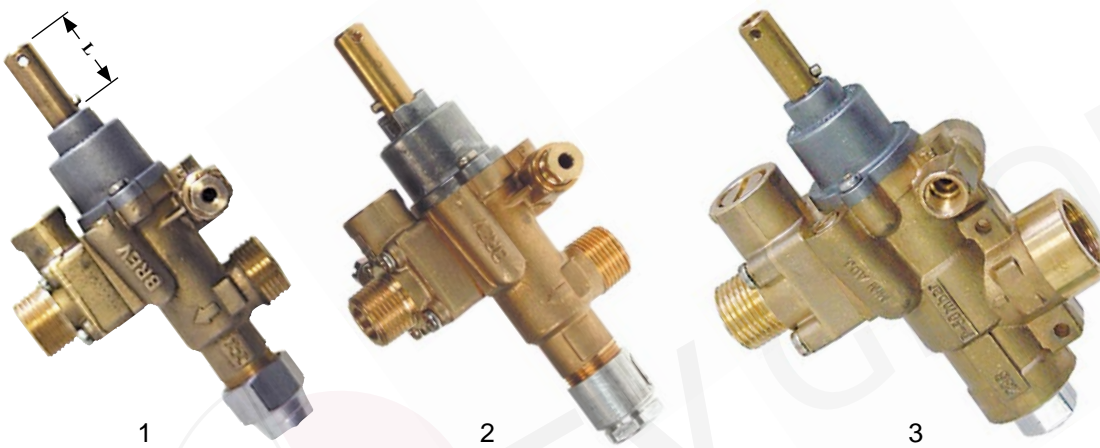

item	order no.	description	gas input	ø pipe input (mm)	ø bypass nozzle (mm)	gas outlet	ø pipe outlet (mm)	thermocouple connection	L (mm)	spindle (mm)
1	101457	PEL22S/V	M20x1,5	12	0,35	M20x1,5	12/10	M8x1	25	
2	101798	PEL22S/V	3/8"	-	0,35	3/8"	-	M10x1	25	
3	101630	PEL23S/V	1/2" ID	-	0,35	1/2" ET	-	M10x1	25	

## accessories and spare parts for JUNKERS



item	order no.	description	for type gas tap
1	101232	thermocouple nut M8x1	
	101233	thermocouple nut M10x1	CH1_
2	101060	magnetic shim	
3	101061	magnetic shim	CH3_
4	101062	magnetic shim	CH4_



item	order no.	description	for type gas tap
1	101218	spindle extension ø 8mm	
2	101219	spindle extension 6x4,6mm	CH1_
3	550396	spindle extension 6x4,6mm	CH3_
4	100945	cotter pin 3,2x10mm	CH4_
5	101285	union screw M8x1, ø 4mm	CH1_
6	101284	olive ø 4mm	CH3_
7	345200	micro switch	CH120/140
			CH340/440

## gas taps STN3R



item	order no.	gas input	ø pipe (mm)	ø bypass nozzle (mm)	pilot connection	gas outlet	ø pipe outlet (mm)	L1/L2 (mm)	suitable for	spindle (mm)
1	106176	3/8"	8	-	M10x1	3/8"	8	17/7	Morice	
	106177	3/8"	8	-	M10x1	3/8"	8	28/-		
	106188	3/8"	8	-	M10x1	3/8"	8	34/-		
2	106178	3/8"	8	-	M10x1 closed	3/8"	8	28/-	Solymac	
	106179	3/8"	8	-	M10x1 closed	3/8"	8	60/-	Solymac	
3	106141	3/8"	8	-	M10x1	3/8"	8	67/9	Bonnet	
	106180	pipe flange ø 21mm	-	-	M10x1	M18x1,5	-	38/-		
4	106182	pipe flange	-	-	M10x1	3/8"	8	27/-	Cometto	
	106181	pipe flange	-	-	M10x1	3/8"	8	25/-	Solymac	

## G

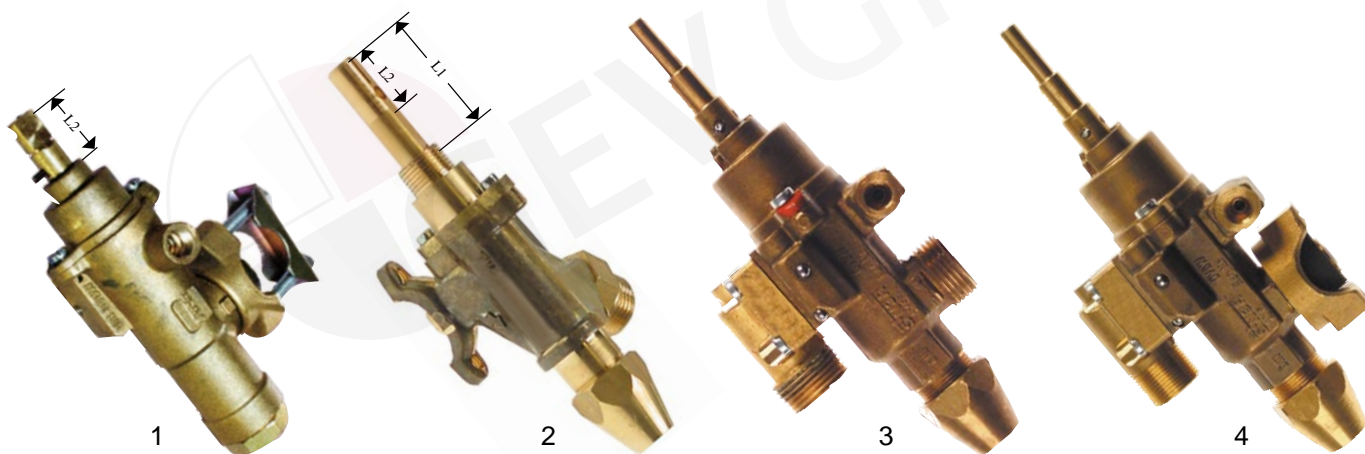

## Gas taps

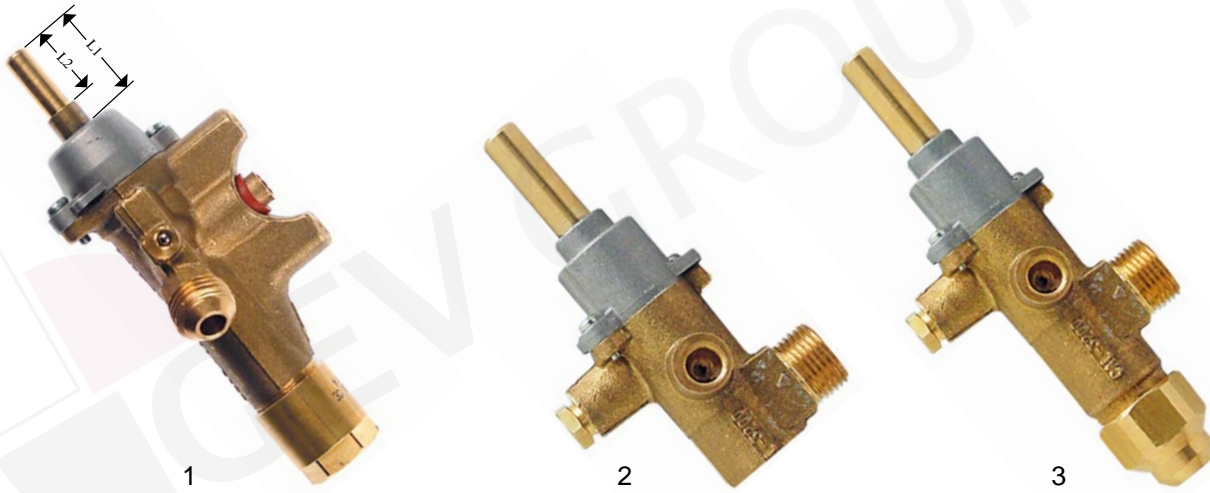

item	order no.	gas input	ø pipe (mm)	ø bypass nozzle (mm)	gas outlet	ø pipe outlet (mm)	thermocouple connection	L1/L2 (mm)	suitable for	spindle (mm)
1	106183	pipe flange ø 21mm	-	-	3/8" ET	-	M9x1	20/-		
	106184	pipe flange ø 21mm	-	-	3/8" ID	10	M9x1	22/-		
	106185	pipe flange ø 21mm	-	-	3/8" ID	10	M9x1	23/-	Charvet	
	106186	pipe flange ø 21mm	-	-	3/8" ID	10	M9x1	20/-	Charvet	
2	101962	pipe flange	-	0	M16x1,25	edge-flange	M8x1	28/14	Tecno MCM	
3	101988	M20x1,5	12	0	M20x1,5	12	M9x1	22/16	Tecno MCM	
	106052	M20x1,5	12	0	M20x1,5	12	M8x1	39/18	Küppersbusch	
4	106053	pipe flange	-	-	3/8"	10	M8x1	39/18	Küppersbusch	

## gas taps COPRECI



item	order no.	type	gas input	ø pipe input (mm)	ø bypass nozzle	gas outlet	ø pipe outlet (mm)	thermocouple connection	L1/L2 (mm)	spindle (mm)
1	106036	CAL-5200	pipe flange	-	0,35	M14x1,5	6	M8x1	24/16	
2	109506	L-3200	M18x1,5	12	0,90	M18x1,5	12	-	30/12	
	109503	CAL-3200	M18x1,5	12	0,55	M18x1,5	12	M8x1	30/12	
	109509	CAL-3200	M18x1,5	12	0,80	M18x1,5	12	M8x1	30/12	
	109504	CAL-3200	M18x1,5	12	0,90	M18x1,5	12	M8x1	30/12	
	109508	CAL-3200	M18x1,5	12	1,20	M18x1,5	12	M8x1	30/12	
	109505	CAL-3200	M18x1,5	12	1,30	M18x1,5	12	M8x1	30/12	
	109500	CAL-3200	M18x1,5	12	0,55	M18x1,5	12	M8x1	46/12	
	109501	CAL-3200	M18x1,5	12	0,90	M18x1,5	12	M8x1	46/12	
	109502	CAL-3200	M18x1,5	12	1,20	M18x1,5	12	M8x1	46/12	

## accessories and spare parts for STN3R

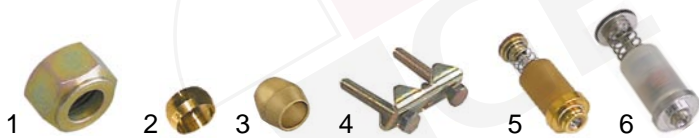

item	order no.	description	thread	ø pipe (mm)
1	101251	union nut	M20x1,5	12
2	101273	olive	-	12
3	101284	olive	-	4
4	101964	clamp	-	-
5	101051	magnetic shim	-	-
6	101058	magnetic shim	-	-

## accessories and spare parts for COPRECI



item	order no.	description	thread	ø pipe (mm)
1	100944	union nut	M18x1,5	12
2	101273	olive	-	12
3	101060	magnetic shim	CAL-5200	-
4	106173	magnetic shim	CAL-3200	-

## gas taps SABAF



item	order no.	type	ø gas input (mm)	ø bypass nozzle (mm)	gas outlet	ø pipe outlet (mm)	front fixing	thermocouple connection	L1/L2 (mm)	spindle (mm)
1	101747	Sabaf 10	14	0,40	1/4"	8	M13x1	M8x1	23/17	
	101748	Sabaf 10	14	0,50	1/4"	8	M13x1	M8x1	23/17	
	101749	Sabaf 10	14	0,74	1/4"	8	-	M8x1	23/17	
2	101396	Sabaf 10	16	0	1/4"	8	-	M8x1	26/12	
	101357	Sabaf 10	16	0,52	1/4"	8	-	plug-in connection	26/12	
3	101890	Sabaf 10	16	0	1/4"	8	-	plug-in connection	26/12	
	101994	Sabaf 10	16	0,65	1/4"	8	-	ø 2mm	26/12	
4	101994	Sabaf 10	16	0,65	1/4"	8	-	ø 2mm	26/12	

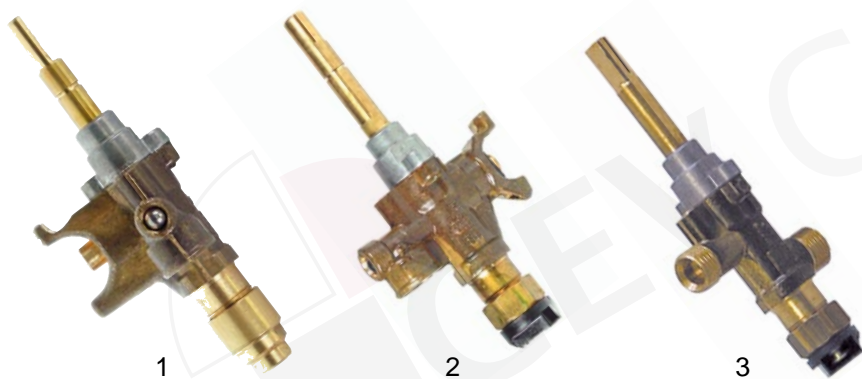

item	order no.	type	ø gas input	ø pipe (mm)	ø bypass nozzle (mm)	gas outlet	ø pipe outlet (mm)	thermocouple connection	L1/L2 (mm)	spindle (mm)
1	106025	Sabaf 10	ø 18mm	-	0,27	M13x1 ID	8	M8x1	35/15	
2	106062	Sabaf 10	ø 16mm	-	0,25	M13x1 ID	8	plug-in connection	45/11	
3	101458	Sabaf 11	1/4"	8	0	1/4"	8	plug-in connection	40/15	

## accessories and spare parts for SABAF







item	order no.	description	thread	ø pipe (mm)
1	520656	union nut	1/4"	8
2	101477	union screw	M13x1	8
3	101277	olive	-	8





item	order no.	description
1	101051	magnetic shim
2	101751	holder for pipe flange
3	101376	gasket for pipe flange

## various gas taps

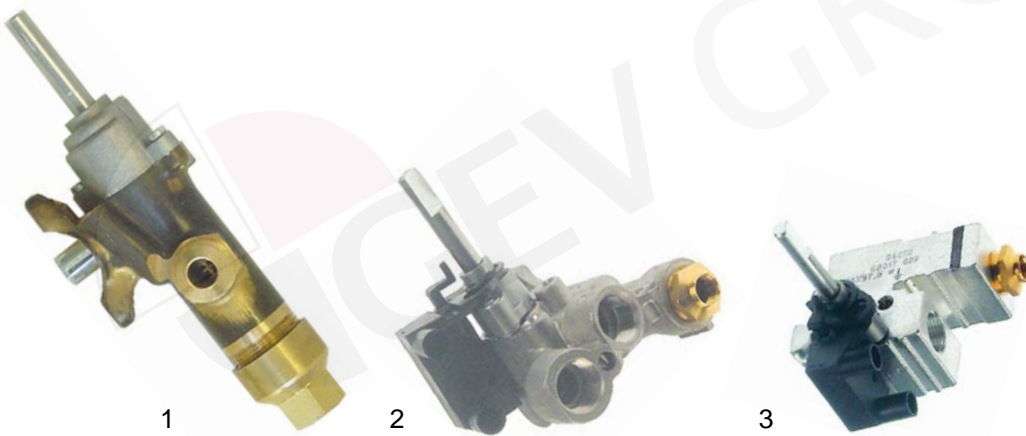

item	order no.	producer	gas input	ø bypass nozzle (mm)	gas outlet	ø pipe outlet (mm)	thermocouple connection	L1/L2 (mm)	spindle (mm)	accessories (page 30)
1	101697	Siral	pipe flange	0,42	1/4" ET	8	M8x1	23/12		types A,C
1	101699	Siral	pipe flange	0,85	1/4" ET	8	M8x1	23/12		types A,C
2	106013	ECA	pipe flange	-	1/4" ET	8	M8x1	20/13		types A,C
3	106015	Imit	pipe flange	0,45		12 (M6x0,75)	M8x1	22/15		types A,C



item	order no.	producer	gas input	ø bypass nozzle (mm)	gas outlet	ø pipe outlet (mm)	thermocouple connection	L1/L2 (mm)	spindle (mm)	accessories (page 30)
1	101891	SKG	pipe flange	0,45	flanged		M8x1	27/12		types B,C
2	101829	SKG	pipe flange	0,32/0,57	M13x1 ID	8	M8x1	30/13		types A,E,F
3	101825	SKG	pipe flange	0,40	M13x1 ID	8	M8x1	30/13		types A,D,F

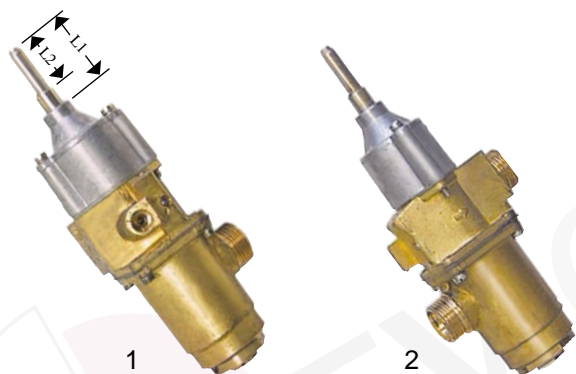

item	order no.	application	producer	gas input	gas outlet	thermocouple connection	L1/L2 (mm)	spindle (mm)
1	101420	cookery	MAW	M22x1,5	M22x1,5	M10x1	35/25	
2	101423	oven without small setting	MAW	M22x1,5	M22x1,5	M10x1	35/25	

## accessories and spare parts for diverse gas taps



item	order no.	description	thread	ø pipe (mm)
1	520656	union nut	1/4"	8
2	101477	union screw	M13x1	8
3	101277	olive	-	8

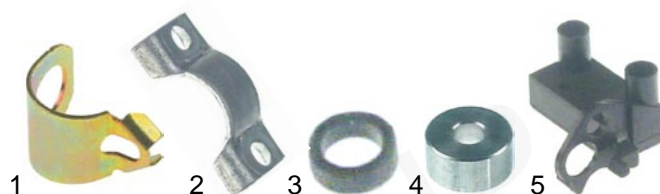

item	order no.	description	type (suitable for gas taps page 29)
1	101828	holder for pipe flange	D
2	101832	holder for pipe flange	E
3	101827	gasket	F
4	101826	micro switch	F
5	101038	ignition switches	F

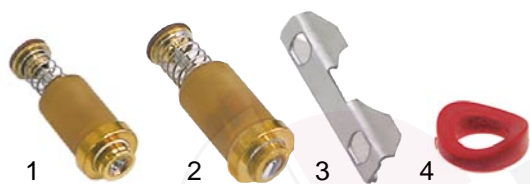

item	order no.	description	type (suitable for gas taps page 29)
1	101051	magnetic shim	A
2	101060	magnetic shim	B
3	101351	holder for pipe flange	C
4	101376	gasket	B



