



# ***IGNITION COMPONENTS***

## *(Pilots, electrodes and thermocouples)*

### *Pilot burners*



### *Electrodes/piezoelectric igniters/ignition push buttons/ignition switches/ignition units/ignition cables*



### *Thermocouples*



**G.E.V. Großküchen-Ersatzteil-Vertrieb GmbH**  
Robert-Koch-Straße 3a  
82152 Planegg/Munich  
Germany

Phone: +49 (0)89 745572-0  
Fax: +49 (0)89 745572-83  
order@gev-online.com  
www.gev-online.com

Member of the  **GEV GROUP**

## Pilot burners SIT



page 4

## Pilot burners JUNKERS/ORKLI



page 8

## Pilot burners ROBERTSHAW



page 10

## Pilot burners GEV/EGA



page 12

## Pilot burners POLIDORO/HONEYWELL



page 14

## Various pilot burners

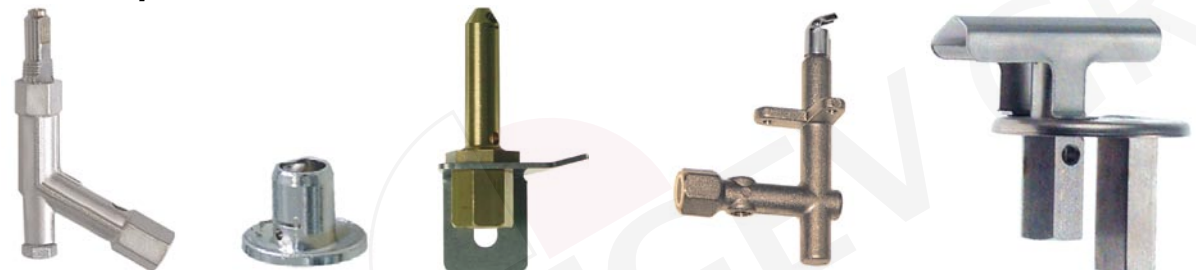

page 15

**Electrodes**



page 19

**Piezoelectric igniters**



page 26

**Ignition push buttons**



page 26

**Ignition units**

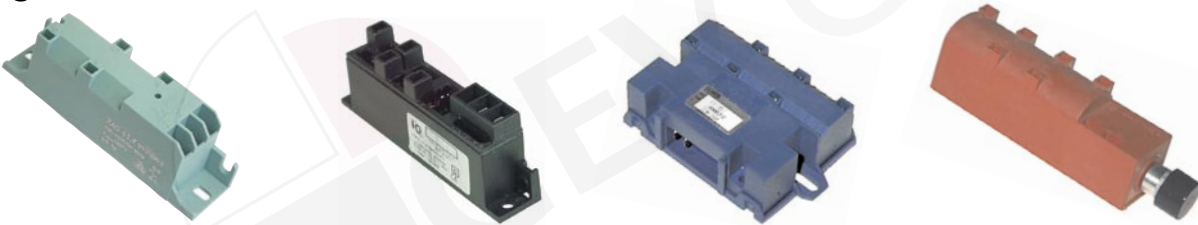

page 27

**Ignition cables**

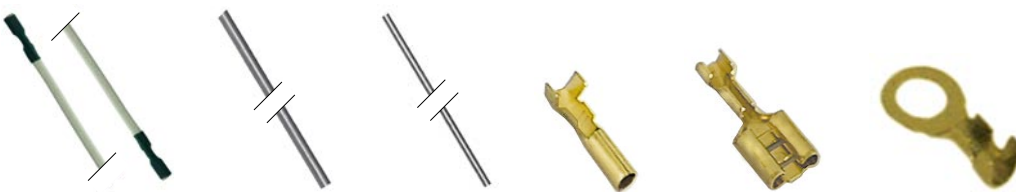

page 27

**Thermocouples**



page 30

## pilot burners SIT universal and accessories

### 1 burner



item	order no.	ø jet (mm)	jet	item	order no.	ø jet (mm)	jet
1	100040	0,20	type A	3	100113	0,35	type A
2	100047	0,20	type A	4	100129	0,35	type C
3	100048	0,20	type A				

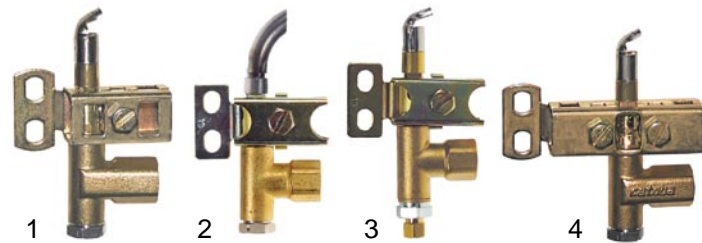

item	order no.	ø jet (mm)	jet	item	order no.	ø jet (mm)	jet
1	100041	0,20	type A	3	100069	0,20	
	100083	0,35	type A	4	100044	0,20	type A
2	100066	0,20	type A				

### 2 burners

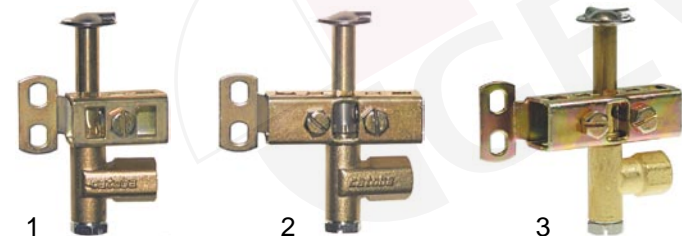

item	order no.	ø jet (mm)	jet	item	order no.	ø jet (mm)	jet
1	100042	0,20	type A	3	100103	0,35	type A
2	100045	0,20	type A				

### 3 burners



item	order no.	ø jet (mm)	jet	item	order no.	ø jet (mm)	jet
1	100043	0,20	type A	2	100106	0,35	type A
	100104	0,35	type A	3	100122	0,24	
2	100046	0,20	type A				

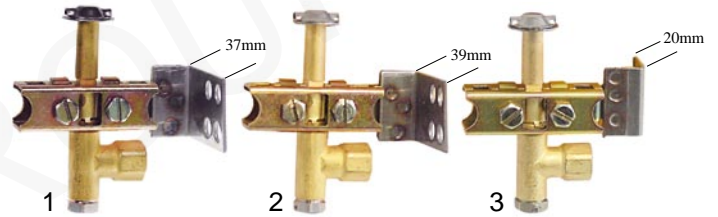

item	order no.	ø jet (mm)	jet	item	order no.	ø jet (mm)	jet
1	100124	0,25	type A	3	100139	0,25	type A
2	102806	0,25	type A				

### pilot burners with mushroom cap



item	order no.	ø jet (mm)	jet	item	order no.	Qty (piece)	description
1	100071	0,20	type A	3	100833	1	mush- room cap
2	100086	0,20	type A		102633	5	
				4	100804	1	gasket

### pilot burners caps



item	order no.	Qty (piece)	description	item	order no.	Qty (piece)	description
1	100841	1	1 burner	4	100843	1	3 burners
	102641	5			102643	5	
2	100832	1	1 burner	5	100831	1	little hat
	102632	5			102631	5	
3	100842	1	2 burners		100885	1	aeration collar
	102642	5		6	102685	5	

Ignition components

© GEV 2007

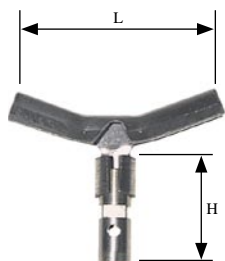

pos.	order no.	dimensions (mm)		description	pos.	order no.	dimensions (mm)		description
		L	H				L	H	
1	102664	40	29	3 burners	5	102816	64	25	3 burners
2	100837	48	24	2 burners	6	102663	64	29	3 burners
3	100836	48	30	2 burners	7	102665	87	28	3 burners
4	100835	48	35	2 burners					

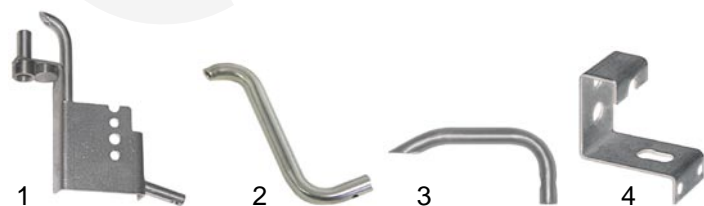

item	order no.	description
1	100099	pilot burner upper part
2	101480	pilot burner upper part
3	100838	pilot burner upper part
4	100890	pilot burner bracket

## pilot burners bottom parts

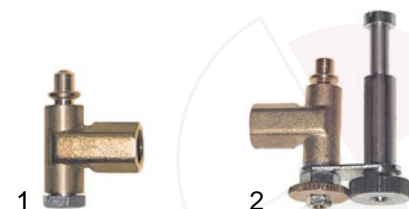

item	order no.	description	ø jet (mm)	jet
1	100881	pilot burner body	0,20	type A
	100882	pilot burner body	0,25	
	100883	pilot burner body	0,35	
2	100090	pilot burner body (adjustable from upper)	0,20	-



item	order no.	description
1	100916	spring
2	100917	aluminium joint
3	100918	locking screw

## pilot burners accessories



item	order no.	Qty (piece)	description
1	100904	1	locking screw for gas line, ø 4mm
	102504	5	
2	100905	1	locking screw for gas line, ø 6mm
	102505	5	
3	100885	1	aeration collar for pilot burners
	102685	5	

## pilot burners brackets/electrodes

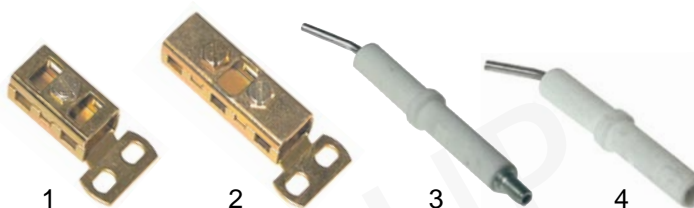

item	order no.	description	item	order no.	description
2	100855	bracket 3-fold	4	100707	igniter ø 2,4

## pilot burner jets (types A-C)



item	order no.	Qty (piece)	ø jet (mm)	jet type	item	order no.	Qty (piece)	ø jet (mm)	jet type
1	100245	1	0,20	A	2	100247	1	0,20	B
	102545	5				102547	5		
	102742	1	0,25	A		100248	1	0,35	B
	100246	1	0,35	A		102548	5		
	102546	5							
3	100789	1	0,21	C					
	100790	1	0,35						

## pilot burners SIT TARGET and accessories

### pilot burners SIT TARGET



item	order no.	description	no. Sit
1	100095	1 burner	0140026
	100097	2 burners	0140020
2	100859	1 burner	0140028
3	100181	1 burner	0150086
4	100074*	2 burners	

\*suitable for OLIS



item	order no.	description	no. Sit
1	100070	1 burner	0150073
2	101931	1 burner	0140018
3	101930*	1 burner	0140_

\*suitable for BARON



item	order no.	description	no. Sit
1	100170	1 burner	0150064
2	100050	2 burners	0140015
3	100144	1 burner	0140001
4	102831	2 burners	0140024



item	order no.	description	no. Sit
1	100198	1 burner	0140104
2	100126*	1 burner	
3	100159**	2 burners	0150_

\*suitable for ZANUSSI (ref. no. 002055)

\*\*suitable for GICO (ref. no. 790200900)



item	order no.	description	no. Sit
1	100094	1 burner	0140102
2	100182	cover	

### accessories for pilot burners SIT TARGET



item	order no.	Qty (piece)	description
1	100701	1	igniter M4
2	100906	1	screw connection for igniter M10x1
	102506	5	
3	100801	1	gasket for pilot burners
4	100803	1	



item	order no.	Qty (piece)	description
1	100907	1	thermocouple nut
	102507	5	
2	100908	1	gas feed nut $\varnothing$ 4mm
	102508	5	
3	100909	1	gas feed nut $\varnothing$ 6mm
	102509	5	
4	100897	1	olive $\varnothing$ 4mm
5	100898	1	olive $\varnothing$ 6mm

### pilot burner jets



pos.	order no.	Qty (piece)	description	$\varnothing$ jet (mm)	no.	for series
1	100204	1	LPG jet	0,18/0,20	14	0140_
2	102604	5	LPG jet			
3	100207	1	natural gas jet	0,40/0,38	27	0140_
4	102607	5	LPG jet			
5	100205	1	LPG jet	0,23/0,26	19	0150_
6	102605	5	LPG jet			
7	100765	1	LPG jet	0,35	20	0150_
8	102799	5	LPG jet			
9	100206	1	natural gas jet	0,60/0,55	36	0150_
10	102606	5	LPG jet			
11	100216	1	natural gas jet	0,45	38	0150_
12	102516	5	LPG jet			

## pilot burners SIT series 160 and accessories

### pilot burners SIT series 160

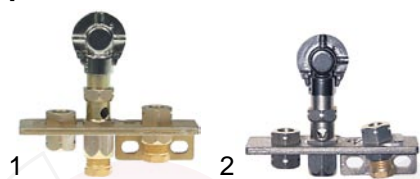

item	order no.	description	jet	ø gas line (mm)	no. Sit
1	100872	3 burners	no. 51	6	0160005
2	100055	2 burners	-	-	0160101



item	order no.	description	no. Sit
1	100105	3 burners	0160042
2	100052	2 burners	0160103

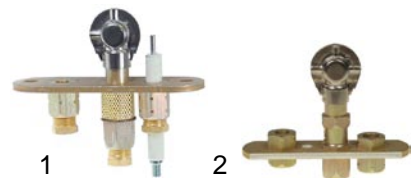

item	order no.	description	jet	ø gas line (mm)	no. Sit
1	102840	2 burners	no. 41	6	0160105
2	102946	3 burners	-	-	0160075



item	order no.	description	no. Sit
1	100109	1 burner	0160002
2	100056	3 burners	0160032



item	order no.	description	no. Sit
1	100054	2 burners left	0160022
2	100053	2 burners right	0160012

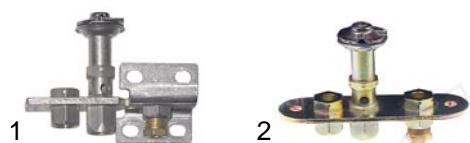

item	order no.	description	no. Sit
1	100049	2 burners right	0160046
2	101898	3 burners	0160501

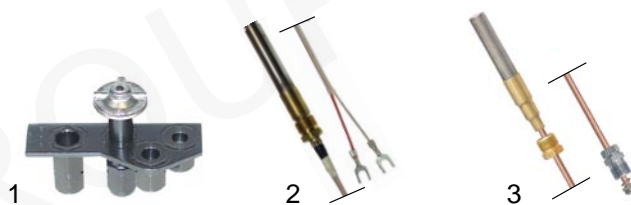

item	order no.	description	no. Sit
1	100110	3 burners	0190603
2	102116	thermoelectric generator 750mV, 600mm	-
3	580035	thermoelectric generator 750mV, 820mm	-

### accessories for pilot burners SIT series 160



item	order no.	Qty (piece)	description
1	100701	1	igniter
2	100906	1	electrode nut
	102506	5	
3	100801	1	gasket



item	order no.	Qty (piece)	description
1	100907	1	screw for thermocouple
	102507	5	
2	100908	1	union screw for gas line ø 4mm
	102508	5	
3	100909	1	union screw for gas line ø 6mm
	102509	5	
4	100870	1	locking ring for gas line ø 4mm
5	101857	1	locking ring for gas line ø 6mm

### pilot burner jets



pos.	order no.	Qty (piece)	description	ø jet (mm)	no.
1	100200	1	LPG jet	0,20	20
2	100203	1	LPG jet	0,25	25
		5			
4	100201	1	LPG jet	0,30	30
5	102501	5			
6	102698	1	LPG jet	0,35	35
7	100202	1	natural gas jet		
8	102502	5		0,41	41
9	100869	1	natural gas jet	0,51	51

## pilot burners JUNKERS/ORKLI and accessories

### pilot burners JUNKERS/ORKLI

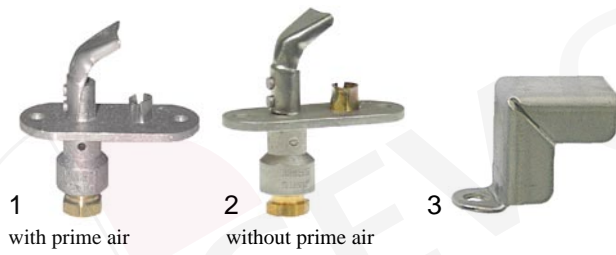

item	order no.	description	jet	ø gas line (mm)	no. Junkers
1	100101	LPG	no. 2	4	CB 503003
	100058	natural gas	no. 26	4	CB 503006
	100118	natural gas	no. 3	4	CB 503002
2	100107	LPG	no. 10	4	CB 503009
	100080	natural gas	no. 6	4	CB 503010
3	100966	covering hood	-	-	-



item	order no.	description	jet	ø gas line (mm)	no. Junkers
1	100085	natural gas	no. 6	6	CB 502031
2	100132	city gas	no. 4	4	CB 502032
	100061	natural gas	no. 6	6	-
3	100062	natural gas	no. 6	6	CB 502021



item	order no.	description	jet	ø gas line (mm)	no. Junkers
1	100057	natural gas	no. 44	4	CB 505102
	100134	natural gas	no. 45	4	CB 505101
2	100802	gasket	-	-	-
	100135	natural gas	no. 45	4	CB 505105
3	100081	natural gas	no. 44	4	CB 505111
	100116	LPG	no. 42	4	CB 505122
4	100805	gasket	-	-	-



item	order no.	description	jet	ø gas line (mm)	no. Junkers
1	100133	natural gas	no. 44	4	CB 505139
	100138	natural gas	no. 64	4	CB 505137
	102954	LPG	no. 52	4	CB 505121
	102955	LPG	no. 49	4	CB 505120
2	100119	natural gas	no. 45	4	CB 505141
3	102842	gasket	-	-	-



item	order no.	description	jet	ø gas line (mm)	no. Junkers
1	100059	natural gas	no. 4	4	CB 505004
	100060	natural gas	no. 5	4	CB 505070
2	100805	gasket	-	-	-
3	100073	natural gas	no. 9	6	CB 505018

### accessories for pilot burners JUNKERS/ORKLI



item	order no.	Qty (piece)	description	pilot burner types
1	100704	1	igniter	CB 502_
2	100702	1	igniter	CB 505_
3	100703	1	igniter	CB 505_
4	101292	1	igniter screw	CB 502/505
	102592	10	igniter screw	CB 502/505
5	100900		aeration collar	CB 5020_



item	order no.	Qty (piece)	description	pilot burner types
1	100719	1	igniter	CB 50202_
2	101291	1	igniter screw	CB 50202_
	102591	5	igniter screw	CB 50202_
3	101295	1	thermocouple sleeve	CB 502/505
	102595	10	thermocouple sleeve	CB 502/505
4	100907	1	thermocouple screw	CB 502/505
	102507	5	thermocouple screw	CB 502/505



## ignition lines accessories



item	order no.	Qty (piece)	description	pilot burner types
1	101283	1	union screw for gas line ø 4mm	universal
	102583	10		
2	100909	1	union screw for gas line ø 6mm	universal
	102509	5		
3	101281	1	locking ring for gas line ø 4mm	CB 502/503
	102581	10		
4	101287	1	locking ring for gas line ø 6mm	CB 502/503
	102587	10		
5	101282	1	locking ring for gas line ø 4mm	CB 505_
	102582	10		
6	101288	1	locking ring for gas line ø 6mm	CB 505_
	102588	10		

## pilot burner jets



pos.	order no.	Qty (piece)	gas type	code	pressure (mbar)	pilot burner types
1	100220	1	LPG	2	50	CB 503
2	102520	10				
3	100221	1	LPG	29	30	CB 50203_
4	102521	10				
5	100222	1	LPG	5	50	CB 50203_
6	102522	10				
7	100223	1	natural gas	3	15	CB 503
8	102523	10				
9	100224	1	natural gas	26	25	CB 503
10	102524	10				
11	100225	1	LPG	39	30	CB 503
12	102525	10				
13	100227	1	natural gas	6	25	CB 50203_
14	102527	10				
15	100228	1	city gas	4	8	CB 50203_
16	102528	10				

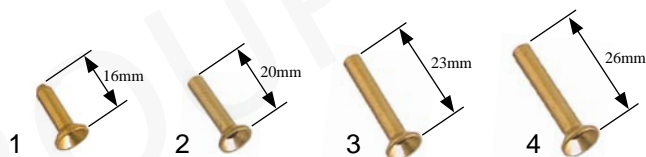

item	order no.	Qty (piece)	gas type	code	pressure (mbar)	pilot burner types
1	100210	1	LPG	46	30	CB 5051_
	102510	10				
	100211	1	natural gas	44	25	CB 5051_
	102511	10				
	100212	1	LPG	42	50	CB 5051_
	102512	10				
	100213	1	natural gas	45	20	CB 5051_
	102513	10				
	100237	1	natural gas	48	20	CB 5051_
	102537	10				
	100229	1	LPG	52	30	CB 5051_
	2	100260	1	LPG	10	50
102560		10				
3	100218	1	natural gas	6	15	CB 503_ without prime air
	102518	10				
4	100261	1	natural gas	23	25	
	102661	10				



pos.	order no.	Qty (piece)	gas type	code	pressure (mbar)	pilot burner types
1	100230	1	LPG	2	50	CB 5050_
	102530	10				
2	100231	1	natural gas	4	25	CB 5050_
	102531	10				
3	100232	1	natural gas	9	25	CB 5050_
	102532	10				
4	100233	1	LPG	8	50	CB 5050_
	102533	10				
5	100234	1	natural gas	14	20	CB 5050_
	102534	10				
6	100217	1	LPG	3	30	CB 5050_
	102519	10				

## pilot burners ROBERTSHAW and accessories

types (flame exit)

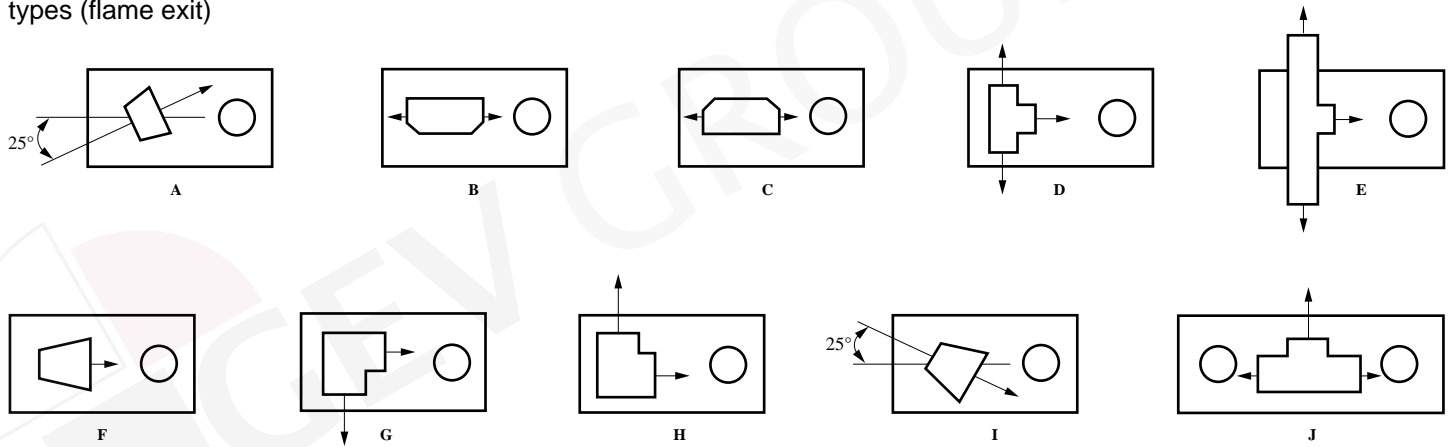

item	order no.	description	gas type	ø jet (mm)	no. Robertshaw	flame type
1	106079	1 burner	natural gas	0,18	2CHL-6	A
2	580034	2 burners	natural gas	0,18	3CH-6	B
3	106083	2 burners	natural gas	0,18	3CHL-6	C



item	order no.	description	gas type	ø jet (mm)	no. Robertshaw	flame type
1	106082	2 burners	natural gas	0,16	3CH-1	C
2	106084	3 burners	natural gas	0,18	4CH-1	D
3	106137	3 burners	LPG	0,16	6CH24-1	E (L=63)
	106117	3 burners	natural gas	0,26	6CH24-1	E (L=63)

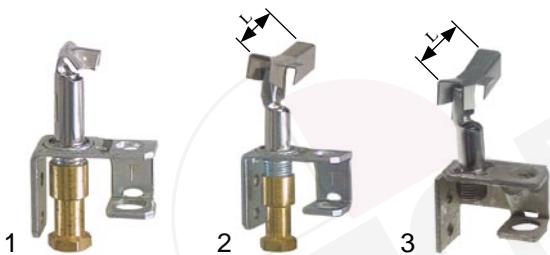

item	order no.	description	gas type	ø jet (mm)	no. Robertshaw	flame type
1	580050	3 burners	LPG	0,11	4CH-6	D
2	580049	3 burners	natural gas	0,22	6CH14-6	E (L=38)
3	106089	3 burners	-	without	6CH14-6 (old holder type)	E (L=38)

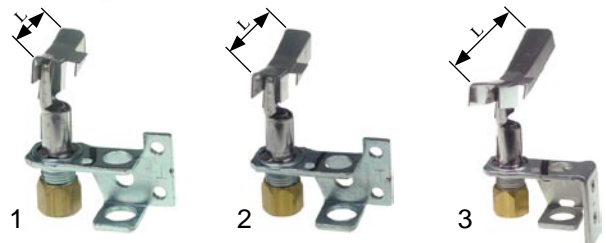

item	order no.	description	gas type	ø jet (mm)	no. Robertshaw	flame type
1	106091	3 burners	natural gas	0,26	6CH10-1	E (L=26)
2	106092	3 burners	natural gas	0,26	6CH14-1	E (L=38)
3	106090	3 burners	natural gas	0,26	6CH30-4	E (L=76)



item	order no.	description	gas type	ø jet (mm)	no. Robertshaw	flame type
1	106078	1 burner	natural gas	0,18	2C-2	F
2	100117	1 burner	natural gas	0,18	2CH-1	F
3	106114	2 burners	natural gas	0,16	5CHR-1	G
4	106116	2 burners	natural gas	0,16	5CHL-1	H

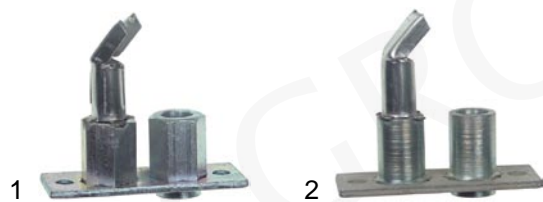

item	order no.	description	gas type	ø jet (mm)	no. Robertshaw	flame type
1	106080	1 burner	-	without	2CHR-7	I
2	106081	1 burner	-	without	2CH-7	F

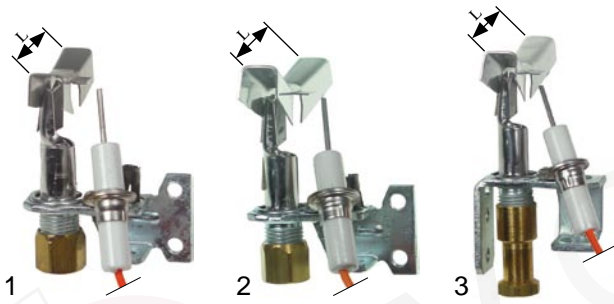

item	order no.	description	gas type	jet	no. Robertshaw	flame type
1	106096	3 burners	natural gas	0,26	6S14-1	E (L=38)
2	106095	3 burners	natural gas	0,26	6S24-1	E (L=63)
3	106097	3 burners	natural gas	0,26	6SH24-6	E (L=63)

## accessories for pilot burners ROBERTSHAW



item	order no.	description
1	106109	locking screw for gas line 1/4"
	106111	locking screw for gas line $\phi$ 6mm
2	106113	union nut
3	101482	union nut for gas line 1/4"
4	101483	union nut for gas line 1/4"
5	101481	olive 1/4" CCT



item	order no.	description	gas type	$\phi$ jet (mm)	no. Robertshaw	flame type
1	106093	1 burner	natural gas	0,18	2S-2ER	F
3	106094	3 burners	natural gas	0,26	6S14-2ER	E (L=38)
	106086	3 burners	natural gas	0,26	4SHR-44	J
	106087	3 burners	LPG	0,16	4SHR-44	J



item	order no.	description
1	106109	locking screw for thermocouple 1/4"
2	106112	locking screw for thermocouple T45

## pilot burner jets



item	order no.	gas type	code	
1	106104	natural gas	16	
	100276	natural gas	18	
	106108	natural gas	22	
	100277	natural gas	26	
	100275	LPG	10	
	106107	LPG	11	
	106106	LPG	14	
	106105	LPG	16	
	2	106115	city gas	



item	order no.	description	height (mm)	no. Robertshaw
1	106098	3 burners	44	9BH
2	106101	2 burners	38	9BV3
3	106099	3 burners	28	9BV
4	106100	2 burners	28	9BV3



item	order no.	description	gas type	no. Robertshaw
1	106102	1 burner	LPG	11EA
2	106103	1 burner	natural gas	11EA

## pilot burners GEV-EGA and accessories

### pilot burners GEV-EGA, type A

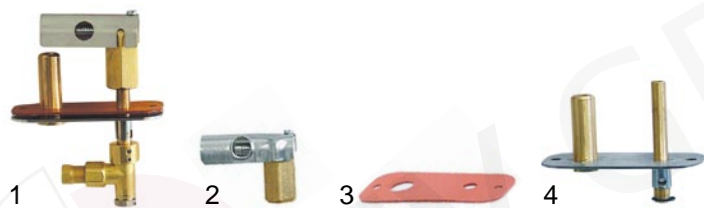

item	order no.	description	suitable for
1	100856	pilot burner LPG	Electrolux, Juno, Zanussi
	100857	pilot burner natural gas	
2	100853	pilot burner upper part	
3	100806	gasket	
4	100847	pilot burner centre part	

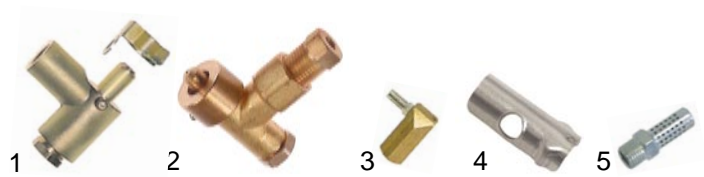

item	order no.	description	suitable for
1	nla*	pilot burner body natural gas	Electrolux, Juno, Zanussi
	nla*	pilot burner body LPG	
2	101599	pilot burner body natural gas	
	101598	pilot burner body LPG	
3	100848	pilot burner upper part	
4	100964	cover	
5	100962	ignition piece	

\*no longer available

### accessories for type A



item	order no.	Qty (piece)	description	suitable for
1	100904	1	locking screw for gas line $\phi$ 4mm	Electrolux, Juno, Zanussi
	102504	5		
2	100916	1	spring	
3	100917	1	aluminium joint	
4	100918	1	locking screw	

### pilot burner jets for type A



pos.	order no.	Qty (piece)	description	$\phi$ (mm)	suitable for
1	100245	1	LPG	0,20	Electrolux, Juno, Zanussi
2	102545	5			
3	102742	1	LPG	0,25	
4	100246	1	natural gas	0,35	
5	102546	5			

### pilot burners GEV-EGA, type B



item	order no.	description	suitable for
1	100088	pilot burner	MKN
2	100960	cover	
3	100961	ignition piece	
4	101228	knurled nut	
5	101259	union nut for gas line $\phi$ 4mm	
6	101284	olive for gas line $\phi$ 4mm	

### pilot burner jets for type B



item	order no.	description	$\phi$ (mm)	suitable for
1	100270	LPG	0,20	MKN
2	101896	LPG	0,22	
3	100271	natural gas	0,30	
4	100272	natural gas	0,35	

### pilot burners GEV-EGA, type C



item	order no.	description	suitable for
1	104257	counter plate	Küppersbusch
2	104258	gasket	
3	104259	centre part	
4	104253	cover	



item	order no.	description	suitable for
1	104254	guide plate	Küppersbusch
2	104255	ignition piece	
3	104252	guide tube	
4	104256	screw connection	
5	104251	spring washer	
6	104250	thermocouple nut	

### pilot burners GEV-EGA, type D



item	order no.	description	suitable for
1	102956	pilot burner C, complete	Ascobloc,
2	102957	pilot burner D, complete	Küppersbusch,
3	102958	pilot burner E, complete	Lohberger, Palux

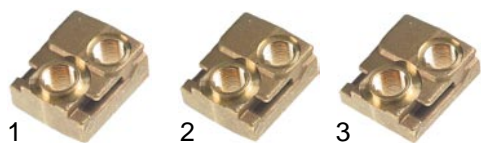

item	order no.	description	height	suitable for
1	101843	base plate for electrode (C)	ø 18mm	Ascobloc, Electrolux, Küppersbusch, Lohberger, Palux, Therma
2	101844	base plate for electrode (D)	ø 15mm	
3	101845	base plate for electrode (E)	ø 11mm	



item	order no.	description	height	suitable for
1	102962	base plate for electrode (C)	ø 18mm	
2	102963	base plate for electrode (D)	ø 15mm	
3	102964	base plate for electrode (E)	ø 11mm	Electrolux, Lohberger, Therma
4	101841	igniter screw	-	
5	102965	igniter	-	
6	102966	aeration collar	-	



item	order no.	description	suitable for
1	101835	pilot burner bottom part (C)	Ascobloc, Electrolux, Küppersbusch, Lohberger, Palux, Therma
2	101834	pilot burner bottom part (D)	
3	101586	pilot burner bottom part (E)	
4	101839	thermocouple screw	

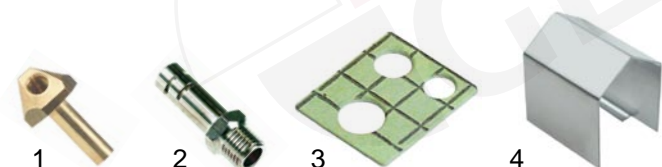

item	order no.	description	suitable for
1	101831	ignition piece intake	
2	101830	ignition piece	Ascobloc, Küppersbusch, Lohberger, Palux
3	101587	gasket	
4	101842	cover	

## pilot burners GEV-EGA, type E



item	order no.	description	suitable for
1	101529	pilot burner complete	Ascobloc, Küppersbusch, Lohberger, Palux
2	101582	pilot burner upper part	
3	101586	pilot burner bottom part	

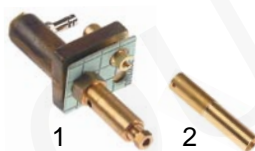

item	order no.	description	suitable for
1	101856	pilot burner complete	ARC, Electrolux, Therma
2	101474	mixing pipe for pilot burner	



item	order no.	description	suitable for
1	102640	pilot burner complete	
2	102833	pilot burner upper part	ARC, Electrolux, Therma
3	101854	pilot burner bottom part	
4	101779	igniter	
5	100906	igniter screw	

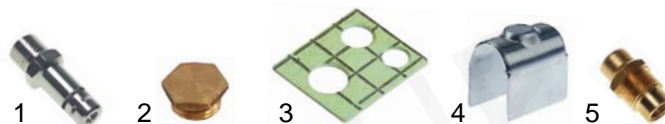

item	order no.	description	suitable for
1	101583	ignition piece	Ascobloc, Electrolux, Küppersbusch, Lohberger, Palux, Therma
2	101584	pilot burner cap	
3	101587	gasket	
4	101848	cover	
5	101585	thermocouple screw	

## accessories for pilot burners GEV-EGA, types C, D, E



item	order no.	Qty (piece)	description	suitable for
1	101285	1	union screw	Ascobloc, Electrolux, Küppersbusch, Lohberger, Palux, Therma
	102585	10	M8x1 ø 4mm	
2	101284	1	olive ø 4mm	
	102584	10		

## pilot burner jets for GEV-EGA, types C, D, E



pos.	order no.	gas type	code	pressure	suitable for
1	100235	LPG	20	50mbar	Lohberger, Ascobloc, Küppersbusch
2	100236	natural gas	35	20mbar	
3	101589	LPG	18	50mbar	
4	101588	natural gas	32	20mbar	Palux
5	101534	LPG	19	50mbar	
6	101543	natural gas	30	20mbar	Therma, Electrolux
7	100979	LPG	25	30mbar	
8	101535	city gas	60		
9	101849	LPG	16	50mbar	GGX
10	101864	LPG	24	30mbar	ARC
11	101865	natural gas	41	20mbar	

## pilot burners POLIDORO and accessories

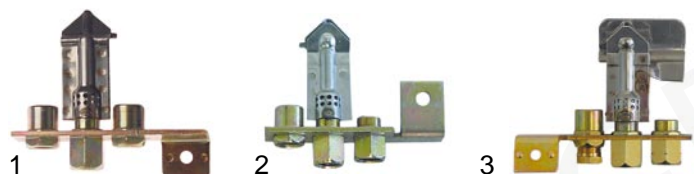

item	order no.	description	item	order no.	description
1	100162	3 burners	3	100076	3 burners
2	100148	3 burners			



item	order no.	description	item	order no.	description
1	100079	3 burners	3	102982	3 burners
2	100051	3 burners			

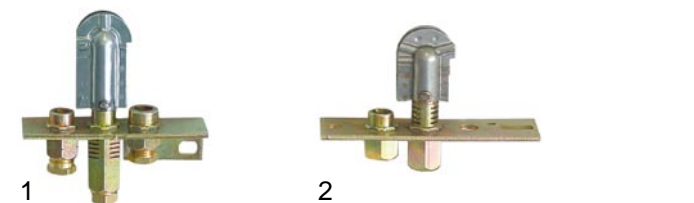

item	order no.	description	item	order no.	description
1	100863	2 burners	2	100867	3 burners

## accessories for pilot burners POLIDORO



item	order no.	Qty (piece)	description
1	100701	1	igniter
2	100906	1	igniter screw
	102506	5	
3	100907	1	thermocouple screw
	102507	5	



item	order no.	Qty (piece)	description
1	100908	1	union screw for gas line $\varnothing$ 4mm
	102508	5	
2	100909	1	union screw for gas line $\varnothing$ 6mm
	102509	5	
3	102795	1	locking ring $\varnothing$ 4mm
	102797	1	locking ring $\varnothing$ 6mm

## pilot burner jets



pos.	order no.	Qty (piece)	gas type	code
1	100208	1	LPG $\varnothing$ 0,20	20.1
	102608	5		
2	100209	1	natural gas $\varnothing$ 0,40	40.1
	102609	5		
3	102699	1	natural gas $\varnothing$ 2x0,25	25.2

## pilot burners HONEYWELL and accessories

### pilot burner HONEYWELL



item	order no.	description	model
1	102885	pilot burner 1 burner	Q349A1026B
2	102886	pilot burner 1 burner	Q349A1091B
3	102887	pilot burner 3 burners	Q327A1683B

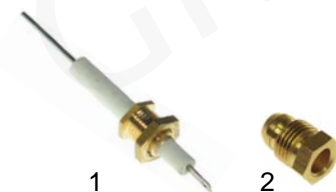

item	order no.	description	model
1	102892	igniter	Q349/Q327
2	102905	union screw for cable $\varnothing$ 6mm	Q349

## pilot burner jets



item	order no.	description	gas type	for model
1	102888	pilot burner jet	natural gas	Q349
	102889	pilot burner jet	LPG	Q349
2	102890	pilot burner jet	natural gas	Q327
3	102891	pilot burner jet	LPG	Q327

## various pilot burners, group A



item	order no.	description	suitable for
1	100082	pilot burner	
2	100834	mushroom cap	EKU
3	101860	nut M10x1	



item	order no.	description	suitable for
1	102979	pilot burner	
2	102980	mushroom cap	Mareno
3	101860	nut M10x1	



item	order no.	description	suitable for
1	100091	pilot burner	
2	100919	spring	Ambach
3	520120	clip	



item	order no.	description	suitable for
1	101899	pilot burner	
2	101929	mushroom cap	Baron
3	101860	nut M10x1	

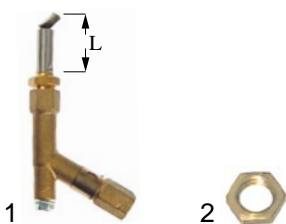

item	order no.	description	suitable for
1	102829	pilot burner (L=34mm)	
	102830	pilot burner (L=28mm)	Thielmann
2	101860	nut M10x1	



item	order no.	description	suitable for
1	100078	pilot burner	
2	102067	nut M8x1	EKU
3	100092	pilot burner	
4	101860	nut M10x1	Modular



pos.	order no.	description	suitable for
1	100068	pilot burner	Gico/Nayati

## accessories for group A



item	order no.	Qty (piece)	description	suitable for
1	100870	1	olive for gas line $\varnothing$ 4mm	
2	101283	1	union screw for gas line $\varnothing$ 4mm	Ambach, Baron, EKU, Modular, Thielmann
	102583	10		
3	101857	1	locking ring for gas line $\varnothing$ 6mm	
4	100909	1	union screw for gas line $\varnothing$ 6mm	
	102509	5		
5	101281	1	locking ring for gas line $\varnothing$ 4mm	Gico, Nayati
	102581	10		
6	101283	1	union screw for gas line $\varnothing$ 4mm	
	102583	10		

## pilot burner jets for group A



pos.	order no.	Qty (piece)	description	$\varnothing$ (mm)	code	suitable for
1	100200	1	LPG jet	0,20	no. 20	
2	100203	1	LPG jet	0,25	no. 25	
3	102503	5	LPG jet	0,25	no. 25	Ambach, Baron, EKU, Gico, Modular, Nayati, Thielmann
4	100201	1	LPG jet	0,30	no. 30	
5	102501	5	LPG jet	0,30	no. 30	
6	102698	1	LPG jet	0,35	no. 35	
7	100202	1	natural gas jet	0,41	no. 41	
8	102502	5	natural gas jet	0,41	no. 41	
9	100869	1	natural gas jet	0,51	no. 51	

## various pilot burners, group B



item	order no.	description	suitable for
1	100601	pilot burner bracket	
2	100075	pilot burner without ignition peak	Malag
3	100600	ignition peak	



item	order no.	description	suitable for
1	102918	pilot burner cover	
2	102919	pilot burner upper part	Wamsler
3	102920	pilot burner plate	
4	102921	pilot burner bottom part	

## accessories and pilot burners jets for group B



item	order no.	Qty (piece)	description	suitable for
1	101285	1	union screw M8x1	
	102585	10	for gas line ø 4mm	
2	101284	1	olive for	
	102584	10	gas line ø 4mm	Lohberger, Malag, Wamsler
3	100214	1	LPG jet ø 0,16mm	
	102514	5		
	102793	1	LPG jet ø 0,23mm	
	100215	1	natural gas jet ø 0,16mm	
	102515	5		

## various pilot burners, group C



item	order no.	description	suitable for
1	100087	pilot burner M8x1	
2	100096	pilot burner M10x1	Ambach
3	101293	gasket (aluminium)	

## accessories and pilot burner jets for group C



item	order no.	Qty (piece)	description	suitable for
1	101294	1	union nut M10x1	
2	101284	1	olive ring for	
	102584	10	gas line ø 4mm	
3	100255	1	LPG jet ø 0,20	
	102555	5		Ambach
	102770	1	LPG jet ø 0,25	
	100252	1	LPG jet ø 0,35	
	102552	5		
	100256	1	natural gas jet ø 0,40	
	102556	5		

## various pilot burners, group D



item	order no.	description	suitable for
1	102859	pilot burner LPG	
	102860	pilot burner natural gas	Heidebrenner
2	102854	pilot burner bracket	
3	102862	pilot burner bracket	

## accessories and pilot burner jets for group D



item	order no.	Qty (piece)	description	suitable for:
1	101281	1	locking ring	
	102581	10	for gas line ø 4mm	
2	101283	1	union screw	
	102583	10	for gas line ø 4mm	Heidebrenner
3	102863	1	igniter	
4	102878	1	igniter holder	



pos.	order no.	gas type	Qty (piece)	code	pressure
1	100222	LPG	1	5	50mbar
2	102522		10		
3	100227	natural gas	1	6	25mbar
4	102527		10		



## various pilot burners, group E



pos.	order no.	description	suitable for
1	100065	pilot burner	Angelo Po

## accessories and pilot burner jets for group E



item	order no.	Qty (piece)	description	suitable for:
1	101282	1	locking ring for gas line ø 6mm	Angelo Po
	102582	10		
2	100909	1	union screw for gas line ø 6mm	
	102509	5		
3	100831	1	pilot burner cap	
	102631	5		



item	order no.	gas type	Qty (piece)	code	pressure (mbar)
1	100220	LPG	1	2	50
	102520		10		
1	100225	LPG	1	39	30
	102525		10		
1	100224	natural gas	1	13	25
	102524		10		
2	100253	LPG	1	2	50
	100240	LPG	1	39	30
	100241	natural gas	1	13	25
			10		

## various pilot burners, group F



pos.	order no.	description	suitable for
1	100089	pilot burner	Mareno



item	order no.	description	code	ø gas line (mm)
1	102967	2 burners right	14	6
2	102971	2 burners left	14	6
3	102975	2 burners right, with prime air	14	6

## accessories and pilot burner jets for group F



item	order no.	Qty (piece)	description
1	101282	1	locking ring for gas line ø 4mm
	102582	10	
2	101283	1	union screw for gas line ø 4mm
	102583	10	
3	101288	1	locking ring for gas line ø 6mm
	102588	10	
4	100909	1	union screw for gas line ø 6mm
	102509	5	
5	100701	1	igniter
6	100906	1	electrode nut igniter
	102506	5	



pos.	order no.	description	Qty (piece)	code	pressure (mbar)
1	100230	LPG	1	2	50
	102530		10		
2	100231	natural gas	1	4	25
	102531		10		
3	100232	natural gas	1	9	25
	102532		10		
4	100233	LPG	1	8	50
	102533		10		
5	100234	natural gas	1	14	20
	102534		10		
6	100217	LPG	1	3	30
	102519		10		

## various pilot burners, group G



item	order no.	description	suitable for
1	100127	pilot burner 2 burners, left	Silko
2	100128	pilot burner 2 burners, right	



pos.	order no.	description	suitable for
1	102906	pilot burner 1 burner	Salvis



pos.	order no.	description	suitable for
1	100879	pilot burner 1 burner	Zanussi, Therma, Electrolux

## accessories and pilot burner jets for group G



item	order no.	Qty (piece)	description	suitable for
1	100870	1	locking ring for gas line ø 4mm	
2	101283	1	union screw	Zanussi
	102583	10	for gas line ø 4mm	
3	100907	1	thermocouple screw	
	102507	5		



pos.	order no.	Qty (piece)	description	ø (mm)	code	suitable for
1	100200	1	LPG jet	0,20	no. 20	
2	100203	1	LPG jet	0,25	no. 25	
3	102503	5	LPG jet			
4	100201	1	LPG jet	0,30	no. 30	Zanussi
5	102501	5	LPG jet			
6	102698	1	LPG jet	0,35	no. 35	
7	100202	1	natural gas jet	0,41	no. 41	
8	102502	5	natural gas jet			
9	100869	1	natural gas jet	0,51	no. 51	

## various pilot burners, group H

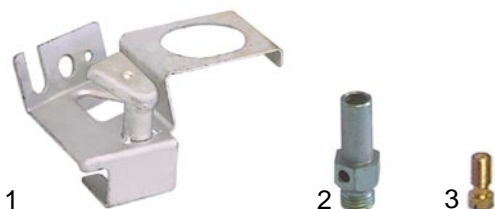

item	order no.	description	suitable for
1	100130	pilot burner 1 burner	
2	100981	pilot burner mixing head	Nagema
3	100970	pilot burner jet (city gas)	

## various pilot burners, group I



pos.	order no.	description	suitable for
1	102894	pilot burner LPG	Theobald
2	102895	pilot burner natural gas	



item	order no.	description	suitable for
1	102897	pilot burner LPG	
	102896	pilot burner natural gas	
2	102899	pilot burner LPG	SFA
	102898	pilot burner natural gas	
3	102901	pilot burner LPG	
	102900	pilot burner natural gas	

## pilot tubings

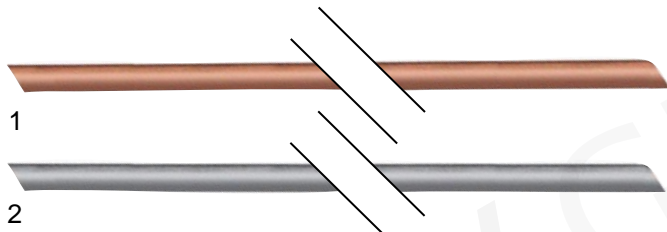

item	order no.	Qty (m)	description	ø pipe (mm)	material
1	102110	3	pilot tubing	4x1	copper
	102111			6x1	
2	102108			4x1	CNS
	102109			6x1	



item	order no.	Qty (piece)	description	ø pipe (mm)
	100904	1	locking screw M10x1	4
	102504	5		
1	100905	1	locking screw M10x1	6
	102505	5		
	101602	1	locking screw M10x1	1/4"
	101494	1	locking screw M11x1	6
	100908	1	union screw M10x1, deep subsidence	4
	102508	5		
2	101283	1	union screw M10x1, deep spot facing	4
	102583	10		
	100909	1	union screw M10x1	6
	102509	5		
3	101284	1	olive	4
	102584	10		
4	101286	1	olive	6
	102586	10		
5	101246	1	olive PEL	4



item	order no.	Qty (piece)	description	ø pipe (mm)	suitable for jet
1	101281	1	locking ring	4	
	102581	10			
2	101287	1	locking ring	6	
	102587	10			
3	101282	1	locking ring	4	
	102582	10			
4	101288	1	locking ring	6	
	102588	10			
5	100897	1	locking ring	4	
6	100898	1	locking ring	6	

## electrodes

key for electrodes at pages 20-21:

### type A (heads)

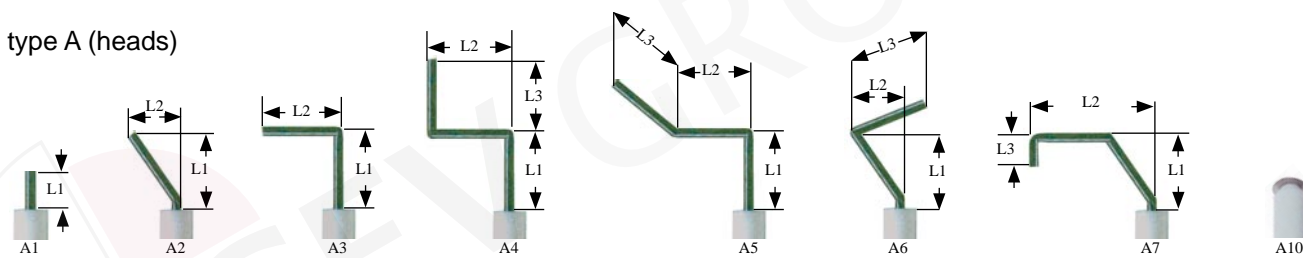

### type B (body)

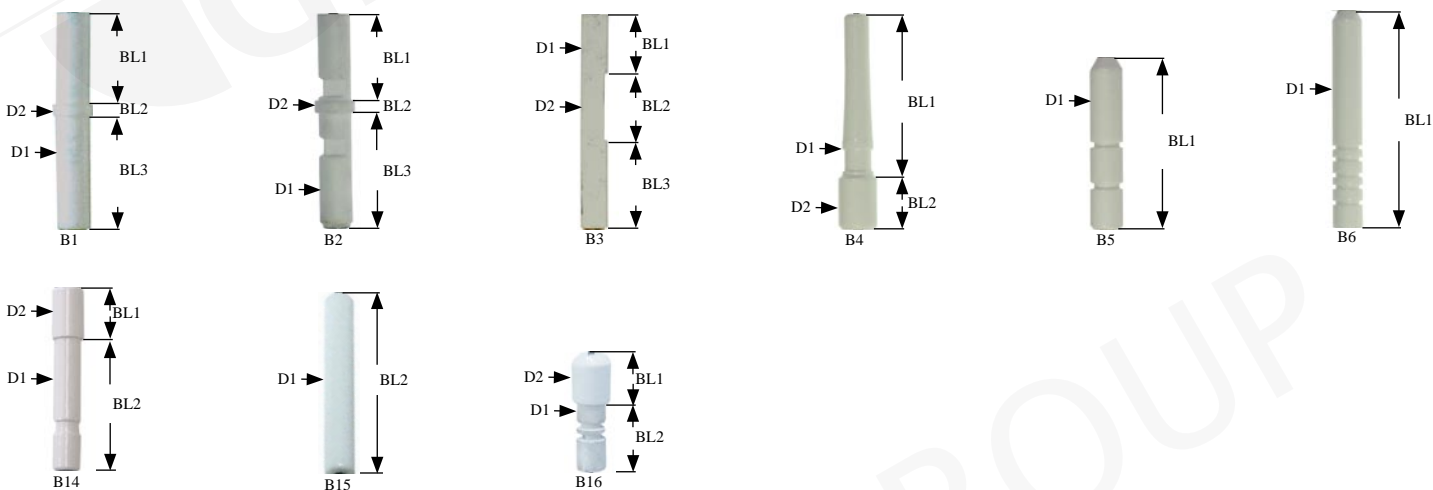

L = length    BL = bodylength    D = diameter

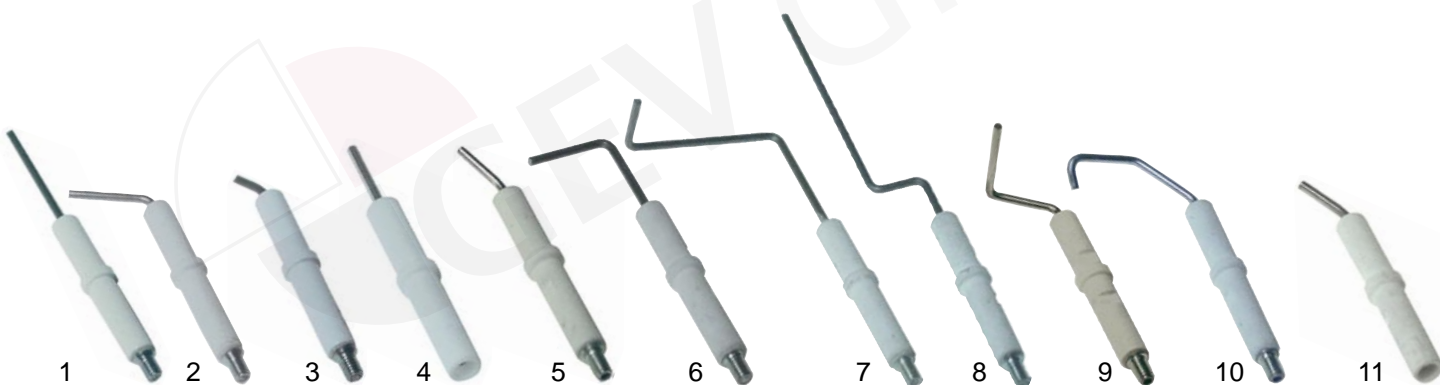

item	order no.	dimensions (mm)								connection	types (key)
		L1	L2	L3	BL1	BL2	BL3	D1	D2		
1	102314	2	-	-	28	3	23	7	9	M4	A1/B1
	100701	32	-	-	18	3	23	7	9	M4	A1/B1
	102399	122	-	-	18	3	23	7	9	M4	A1/B1
2	100719	12	17	-	18	3	23	7	9	M4	A2/B1
3	101779	10	5	-	18	3	23	7	9	M4	A2/B1
4	102330	11	-	-	18	3	23	7	9	ø 2,4mm	A1/B1
5	100706	14	6	-	18	3	23	7	9	M4	A2/B1
6	102333	23	19	-	18	3	23	7	9	M4	A3/B1
	102332	40	46	-	18	3	23	7	9	M4	A3/B1
7	102331	34	40	14	18	3	23	7	9	M4	A5/B1
8	102334	9	12	62	18	3	23	7	9	M4	A4/B2
9	100709	13	23	23	18	3	23	7	9	M4	A6/B2
10	100822	16	25	8	18	3	23	7	9	M4	A7/B2
11	100707	14	6	-	18	3	23	7	9	M4	A2/B2



item	order no.	dimensions (mm)							connection	types (key)	
		L1	L2	L3	BL1	BL2	BL3	D1			D2
1	100703	8	-	-	13	4	22	9	11	M4	A1/B1
2	100704	17	17	-	13	4	22	9	11	M4	A2/B1
3	100702	13	4	-	13	4	22	9	11	∅ 4mm	A2/B1
4	100766	50	-	-	27	3	28	9	11	M4	A1/B1
5	102863	14	7	-	27	3	28	9	11	M4	A3/B1
6	102903	9	5	-	15	16	23	6x7	-	F 2,8x0,8mm	A2/B3
7	100708	11	5	-	15	16	23	6x7	-	M4	A2/B3
8	102374	-	-	-	28	16	9	6x7	-	F 2,8x0,8mm	-/B3
9	100736	-	-	-	14	16	14	6x7	-	F 2,8x0,8mm	-/B3
10	100798	15	9	-	14	16	14	6x7	-	F 2,8x0,8mm	A2/B3



item	order no.	dimensions (mm)							connection	types (key)	suitable for	
		L1	L2	L3	BL1	BL2	BL3	D1				D2
1	100716	6	-	-	38	14	-	8	10	F 2,8x0,8mm	A1/B4	Gico
	100729	1	-	-	41	14	-	8	10	F 2,8x0,8mm	A1/B4	Lotus
2	100768	8	2	-	28	16	-	6	8	F 2,8x0,8mm	A2/B4	Fimar
3	100800	-	-	-	56	-	-	8	-	F 2,8x0,8mm	A10/B6	Lotus
4	102965	-	-	-	43	-	-	8	-	F 2,8x0,8mm	A10/B5	Therma
5	100720	-	-	-	42	-	-	8	-	F 2,8x0,8mm	A10/B5	Küppersbusch
6	100715	-	-	-	15	35	-	8	7	F 2,8x0,8mm	A10/B1	Ambach
7	100717	-	-	-	18	14	21	6	8,5	F 2,8x0,8mm	A10/B1	Zanussi
8	100799	21	-	-	12	18	-	10	7	F 2,8x0,8mm	A1/B16	Lotus
9	102173	1	-	-	17	3	8	5	7	F 2,8x0,8mm	A1/B1	Olis
10	102880	5	12	-	63	-	-	7	-	∅ 4mm	A3/B15	Rational
11	102907	6	6	16	50	-	-	7	-	F 2,8x0,8mm	A5/B15	Salvis
12	100718	55	10	-	22	22	4	10	14	M5	A3/B1	Zanussi

## key for electrodes at pages 22-23:

### type A (heads)

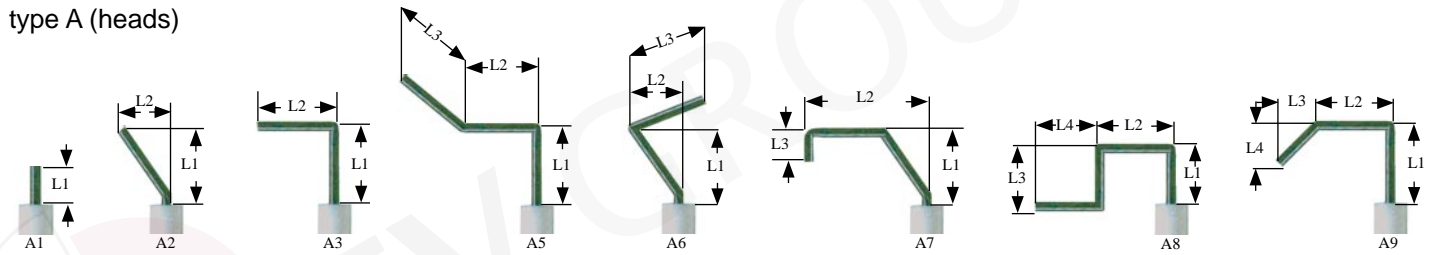

### type B (body)

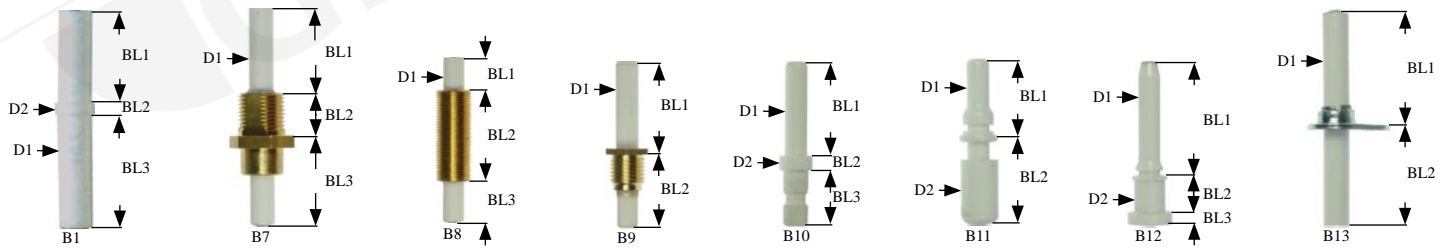

### type C (flanges)

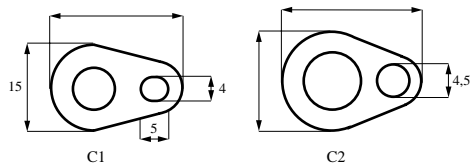

L = length    BL = bodylength    D = diameter

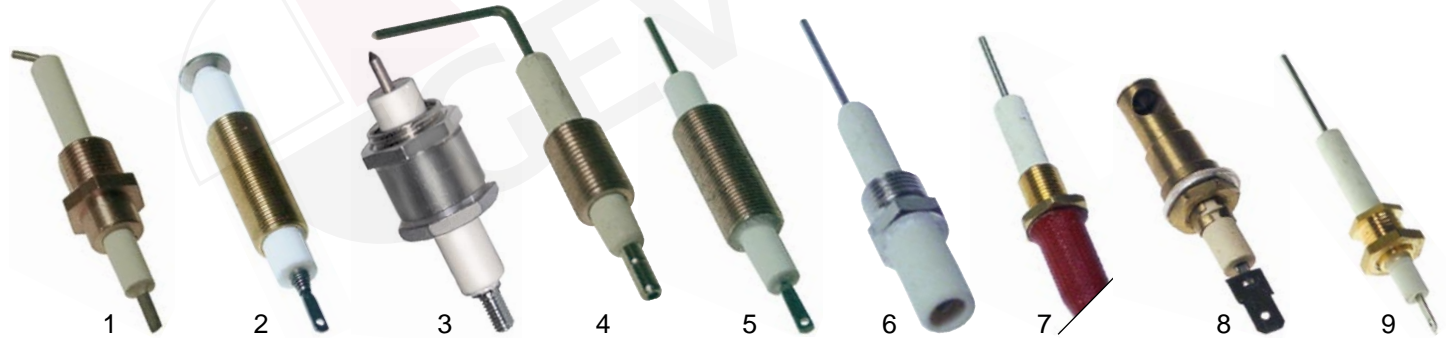

item	order no.	dimensions (mm)										connection	thread	cable length (mm)	suitable for	types (key)
		L1	L2	L3	L4	BL1	BL2	BL3	D1	D2						
1	100712	5	5	-	-	23	11	23	6	-	F 2,8x0,8mm	M12x1	-	Angelo Po	A2/B7	
2	100724	-	-	-	-	13	28	8	8	-	F 2,8x0,8mm	M10x075	-	Juno / Zanussi	A10/B8	
3	100741	8	-	-	-	-	-	-	-	-	M4	PG9	-	MKN	A1/-	
4	100705	15	20	-	-	18	17	10	7	-	ø 4mm	M11x1	-	CB	A3/B8	
5	100721	15	-	-	-	9	25	11	6	-	F 2,8x0,8mm	M10x0,75	-	-	A1/B8	
	100815	12	-	-	-	18	17	9	7	-	M4	M11x1	-	Modular	A1/B8	
6	100743	21	-	-	-	18	8	19	6	-	F 2,8x0,8mm	1/8"	-	Jünger	A1/B7	
7	100819	14	-	-	-	17	9	18	6	-	F 2,8x0,8mm	M8x0,75	1000	Star 10	A1/B7	
8	100874	-	-	-	-	-	-	-	-	-	F 6,3x0,8mm	M10x075	-	Palux	-/-	
9	102892	22	-	-	-	25	19	-	6	-	2,8x0,8mm	1/8"	-	Honeywell	A1/B9	



item	order no.	dimensions (mm)									connection (mm)	cable length (mm)	suitable for	types (key)
		L1	L2	L3	L4	BL1	BL2	BL3	D1	D2				
1	102161	1,5	-	-	-	22	4	13	5	8	F 2,8x0,8	870	Bertos	A1/B10
2	100826	2,5	-	-	-	20	4	13	5	8	F 2,8x0,8	730	MBM	A1/B10
3	100808	2	-	-	-	16	4	13	5	8	F 2,8x0,8	570	Modular	A1/B10
4	100753	1	-	-	-	15	2	22	6	10	F 2,8x0,8	600	Emmepi	A1/B10
	100754	4,5	-	-	-	14	2	22	6	10	F 2,8x0,8	750	Emmepi	A1/B10
5	100167	-	-	-	-	14	2	13	6	8,5	F 2,8x0,8	700	Bertos/FABA	A10/B10
6	100738	-	-	-	-	14	2	15	6	10	ø 2,4	750	Tecnoinox/Zanussi	A10/B10
7	102375	-	-	-	-	14	2	11	6	10	F 2,8x0,8	900	INDESit	A10/B10
8	102329	23	-	-	-	20	23	-	6	10	F 2,8x0,8	700	Lotus	A1/B11
	102328	17	-	-	-	20	23	-	6	10	F 2,8x0,8	1380	Lotus	A1/B11
9	100821	-	-	-	-	25	8	3	5	7	F 2,8x0,8	400	Star 10	A10/B12
10	102312	-	-	-	-	17	3	20	6	8	F 2,8x0,8	900	TECNOEKA	A10/B1
	100733	-	-	-	-	28	3	23	7	8,5	ø 2,4	600	Bertos/GIGA/Silko	A10/B1
11	100746	-	-	-	-	28	3	23	7	8,5	ø 2,4	950	Silko	A10/B1
	100747	-	-	-	-	28	3	23	7	8,5	ø 2,4	1350	Silko	A10/B1
	100732	-	-	-	-	28	3	23	7	8,5	ø 2,4	1750	Silko	A10/B1

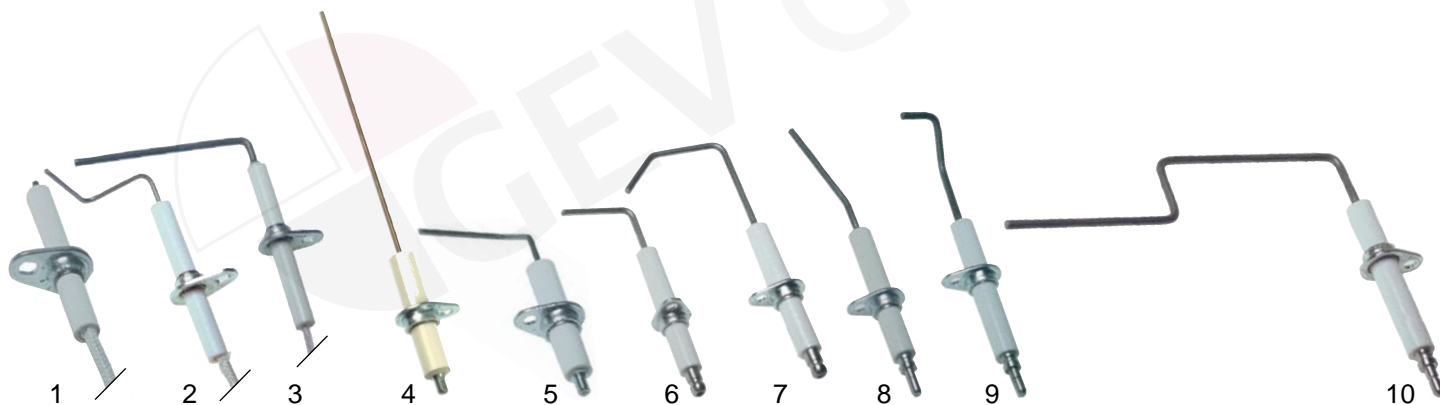

item	order no.	dimensions (mm)									connection	cable length (mm)	suitable for	types (key)
		L1	L2	L3	L4	BL1	BL2	BL3	D1	D2				
1	102316	5	-	-	-	30	24	-	7	-	F 6,3x0,8mm	800	Inoxtrend	A1/B13/C1
2	100727	14	22	31	-	30	24	-	7	-	-	1400	Tornati Forni	A5/B13/C1
3	101862	13	60	-	-	30	30	-	7	-	F 2,8x0,8mm	600	Star 10	A3/B13/C1
4	102323	101	-	-	-	21	21	-	9,5	-	M4	-	Bertos/Emmepi	A1/B13/C2
5	102324	30	16	30	-	21	21	-	9,5	-	M4	-	Mareno	A6/B13/C2
	102360	24	32	-	-	33	25	-	9,5	-	ø 6mm	-	Zanussi	A1/B13/C2
6	102361	20	20	-	-	30	28	-	9,5	-	ø 6mm	-	Zanussi	A1/B13/C2
	102175	31	30	-	-	30	28	-	9,5	-	ø 4mm	-	Zanussi	A1/B13/C2
7	102169	45	30	17	18	30	28	-	9,5	-	ø 6mm	-	Zanussi	A9/B13/C2
8	102359	60	12	-	-	33	25	-	9,5	-	ø 4mm	-	Zanussi	A2/B13/C2
9	102342	48	13	15	-	24	35	-	9,5	-	ø 4mm	-	FOINOX	A6/B13/C2
10	100739	24	71	27	61	24	35	-	9,5	-	ø 4mm	-	Zanussi	A8/B13/C2

## key for electrodes at pages 24-25:

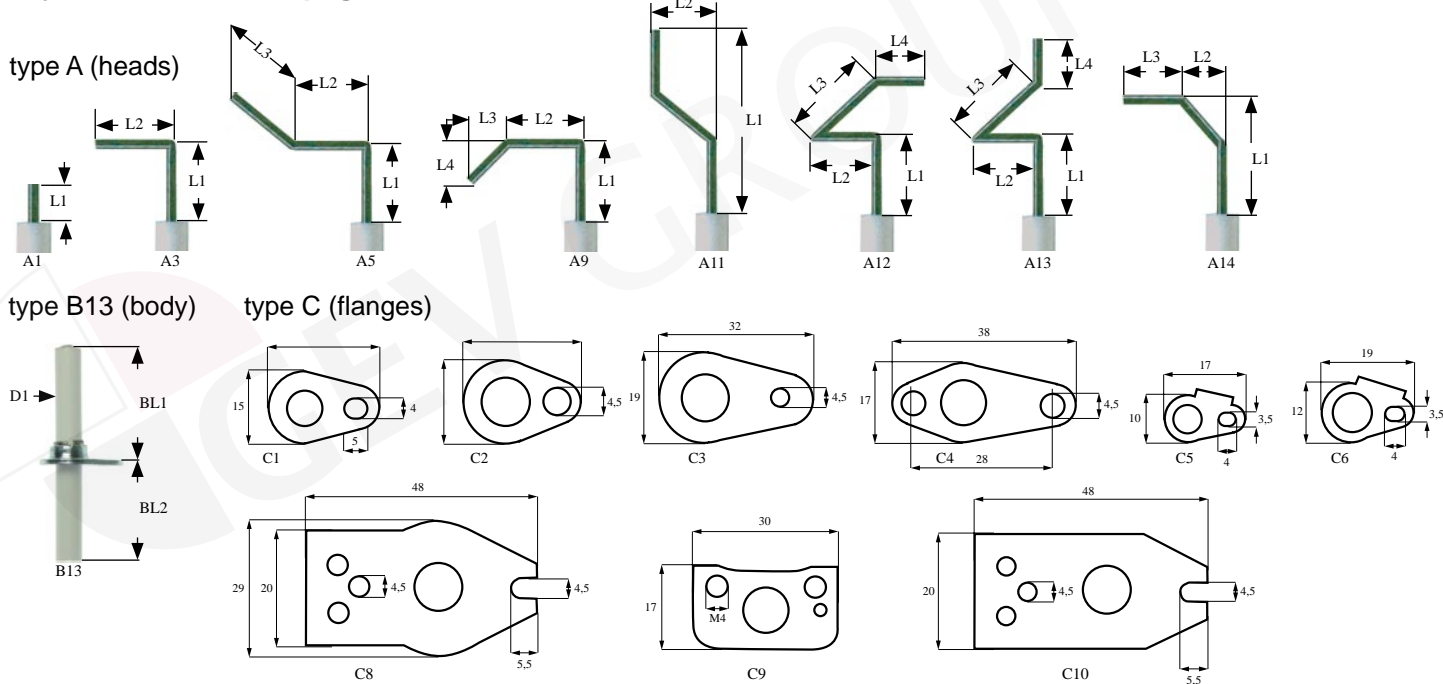

L = length    BL = bodylength    D = diameter



item	order no.	dimensions (mm)									connection (mm)	cable length (mm)	suitable for	types (key)
		L1	L2	L3	L4	BL1	BL2	BL3	D1	D2				
1	101795	12	27	-	-	17	17	-	6,5	-	F 4,8x0,8	960	TECNOEKA	A3/B13/C1
	101794	9	16	-	-	17	17	-	6,5	-	F 2,8x0,8	960	TECNOEKA	A3/B13/C1
2	100726	13	11	-	-	23	20	-	7	-	F 2,8x0,8	1420	TORNATI/Forni	A3/B13/C1
	102808	17	13	-	-	21	32	-	7	-	ø 6	-	MBM	A3/B13/C1
	102809	30	38	-	-	21	32	-	7	-	ø 4	-	MBM	A3/B13/C1
	102807	48	43	-	-	21	32	-	7	-	ø 4	-	MBM	A3/B13/C1
	102335	13	30	-	-	22	30	-	7	-	-	1100	Baron/Olis	A3/B13/C1
	102810	25	12	-	-	24	29	-	7	-	ø 6	-	MBM	A3/B13/C1
3	100734	40	12	-	-	24	29	-	7	-	ø 6	-	MBM	A3/B13/C1
	100735	52	36	-	-	24	29	-	7	-	ø 4	-	MBM	A3/B13/C1
	100711	50	-	-	-	25	29	-	7	-	F 2,8x0,8	-	-	A1/B13/C1
4	100818	18	-	-	-	12	41	-	7	-	F 2,8x0,8	-	Bertos/MBM	A1/B13/C1
	102315	5	-	-	-	30	23	-	7	-	F 2,8x0,8	-	Inoxtrend	A1/B13/C1
	102911	31	-	-	-	20	13	-	7	-	F 2,8x0,8	-	Landmann	A1/B13/C1
5	101789	10	50	-	-	21	25	-	7	-	ø 4	-	Ambach	A3/B13/C1
6	101788	12	38	8	-	21	25	-	7	-	ø 6	-	Ambach	A9/B13/C1
7	102165	42	36	12	-	21	25	-	7	-	ø 6	-	Ambach	A5/B13/C1
8	102167	38	58	38	14	21	25	-	7	-	ø 6	-	Ambach	A12/B13/C1
9	101790	34	60	9	-	21	25	-	7	-	ø 6	-	Ambach	A9/B13/C1
10	102168	37	55	38	38	21	25	-	7	-	ø 4	-	Ambach	A13/B13/C1
11	102166	85	40	-	-	21	25	-	7	-	ø 4	-	Ambach	A11/B13/C1



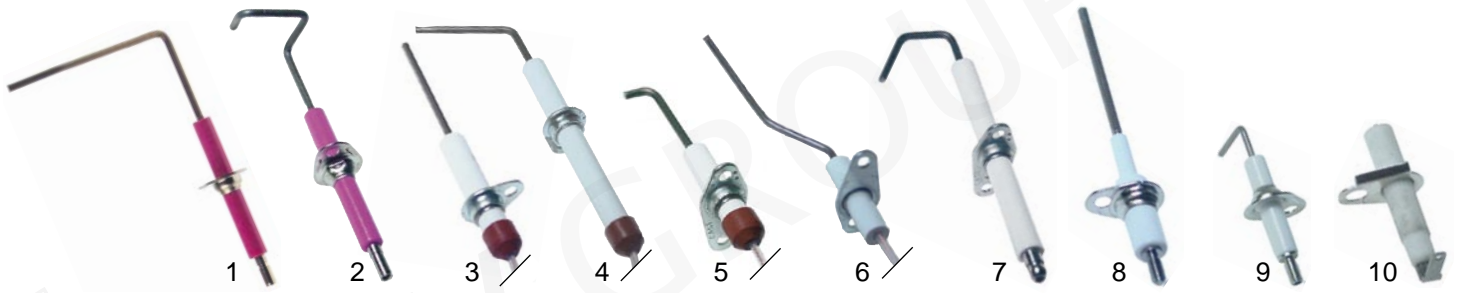

item	order no.	dimensions (mm)										connection	cable length (mm)	suitable for	types (key)
		L1	L2	L3	L4	BL1	BL2	BL3	D1	D2					
1	101791	35	62	-	-	21	29	-	7	-	ø 4mm	-	Ambach	A3/B13/C1	
	100761	15	17	-	-	21	28	-	7	-	ø 4mm	-	Gico	A3/B13/C1	
	100760	26	17	-	-	21	28	-	7	-	ø 4mm	-	Gico	A3/B13/C1	
	100796	46	17	-	-	21	28	-	7	-	ø 4mm	-	Gico	A3/B13/C1	
2	100750	28	18	23	14	21	28	-	7	-	ø 4mm	-	OEM	A12/B13/C1	
3	102345	50	-	-	-	30	18	-	9,5	-	F 4,8x0,8mm	500	Zanussi	A1/B13/C2	
4	102344	35	35	-	-	-	58	-	9,5	-	F 4,8x0,8mm	850	Zanussi	A3/B13/C2	
5	102349	38	10	-	-	23	18	-	9,5	-	F 4,8x0,8mm	700	Zanussi	A3/B13/C4	
6	100780	95	18	-	-	19	19	-	9,5	-	F 4,8x0,8mm	1300	Cuppone	A11/B13/C4	
7	102351	20	35	26	-	45	48	-	9,5	-	ø 6mm	-	Zanussi	A5/B13/C4	
8	100759	54	-	-	-	24	24	-	5	9,5	ø 4mm	-	Fagor	A1/B13/C2	
9	101782	12	18	-	-	15	17	-	7	-	M4	-	Küppersbusch	A3/B13/C1	
10	102326	1	-	-	-	12	16	-	5,5	-	4,8x0,8mm	-	Lotus	A1/B13/C5	
	102327	1	-	-	-	21	15	-	8	-	4,8x0,8mm	-	Lotus	A1/B13/C6	



item	order no.	dimensions (mm)										connection (mm)	cable length (mm)	suitable for	types (key)
		L1	L2	L3	L4	BL1	BL2	BL3	BL4	D1	D2				
1	101784	62	-	-	-	20	18	-	9,5	-	-	F 6,3x0,8	-	Küppersbusch	A1/B13/C8
3	102363	11	21	18	-	17	29	-	-	-	-	ø 6	-	Lainox	A1/B13/C10
	102365	-	-	-	-	17	29	-	-	-	-	ø 6	-	Lainox	A1/B13/C10
	102366	-	-	-	-	17	29	-	-	-	-	ø 6	-	Lainox	A1/B13/C10
4	102364	11	21	18	-	17	29	-	-	-	-	ø 6	-	Lainox	A1/B13/C10
5	102882	-	-	-	-	15	25	-	-	-	-	-	-	Rational	A1/B13/C9
6	102879	-	72	-	-	82	12	-	-	-	-	F 4,8x0,8	-	Rational	A1/B13/-
7	102356	44	-	-	-	44	83	-	15	11	-	-	870	Moretti Forni	A1/-/C1
8	102354	57	-	-	-	25	-	-	32x13	-	-	F 4,8x0,8	570	Moretti Forni	A1/-/
9	102355	19	10	37	-	17	17	140	60	7	8	F 6,3x0,8	1650	Moretti Forni	A1/B13/C1
10	102357	19	10	37	15	17	17	140	60	7	8	F 4,8x0,8	1650	Moretti Forni	A1/B13/C1

## key for electrodes at page 26:

### type A (heads)

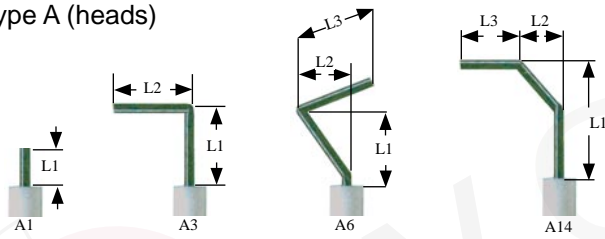

### type B (body)

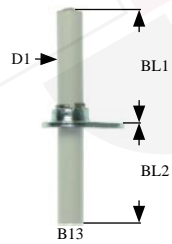

### type C (flanges)

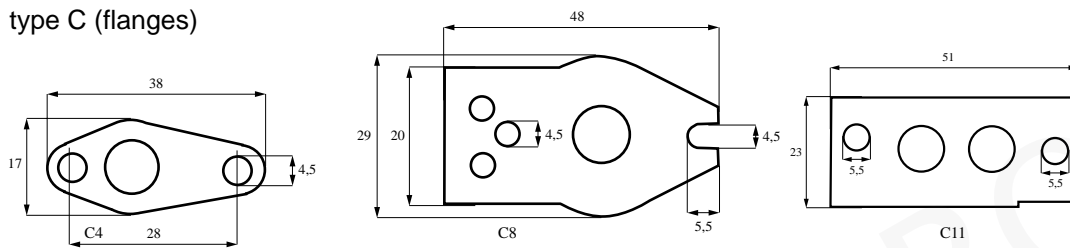

L = length    BL = bodylength    D = diameter



item	order no.	dimensions (mm)										connection	cable length (mm)	suitable for	types (key)
		L1	L2	L3	L4	BL1	BL2	BL3	D1	D2					
1	102834	18	25	12	-	20	19	-	9,5	-	M4	-	MKN	A6/B13/C4	
2	102325	30	18	6	-	21	21	-	9,5	-	M4	-	Mareno	A14/B13/C4	
3	100769	56	12	10	-	19	19	-	9,5	-	F 2,8x0,8mm	800	Cuppone	A14/B13/C4	
4	102322	100	-	-	-	21	21	-	9,5	-	M4	-	Bertos/Emmepi	A1/B13/C4	
5	102352	35	-	-	-	30	18	-	9,5	-	F 2,8x0,8mm	600	Zanussi	A1/B13/C4	
6	102362	21	-	-	-	33	26	-	9,5	-	ø 6mm	-	Zanussi	A1/B13/C4	
8	102268	24	10	-	-	70	25	-	9,5	-	ø 6mm	-	MKN	A3/B13/C4	
	102883	28	-	-	-	80	14	-	9,5	-	F 4,8x0,8mm	600	Rational	A1/B13/C4	
	102884	27	-	-	-	130	24	-	9,5	-	F 2,8x0,8mm	600	Rational	A1/B13/C4	
9	102350	33	11	-	-	20	15	-	9,5	-	F 6,3x0,8/2,8x0,8mm	450	Zanussi	A2/B13/C11	
	102348	33	11	-	-	20	15	-	9,5	-	F 6,3x0,8/2,8x0,8mm	650	Zanussi	A2/B13/C11	
10	101783	26	-	-	-	30	30	-	9,5	-	F 2,8x0,8mm	-	Küppersbusch	A1/B13/C8	
11	101861	12	60	-	-	28	30	-	7	-	F 6,3x0,8/2,8x0,8mm	600	Star 10	A2/B13/-	
12	100742	10	70	-	-	16	25	-	7	-	F 6,3x0,8/2,8x0,8mm	1550	Juno	A2/B13/-	
13	102881	4	12	-	-	66	-	-	24x6	-	ø 4mm	-	Rational	A2/-/-	

## piezoelectric igniters



item	order no.	body	actuation	ø mounting (mm)	connection (mm)
1	100003	metal	pushing	18	F 2,8x0,8
2	100002	metal	rotary	18	F 2,8x0,8
3	100009	plastic	pushing	18	ø 2,4
4	100004	plastic	pushing	18	ø 2,4
5	100005	plastic	pushing	22	ø 2,4



item	order no.	body	actuation	ø mounting (mm)	connection (mm)
1	100013	plastic	pushing	22	ø 2,4
2	100012	plastic	pushing	18	ø 2,4
3	101339	cover for piezoelectric igniter			
4	100007	metal	2-hole	-	F 6,3x0,8
5	100011	metal	3-hole	-	F 6,3x0,8



item	order no.	body	actuation	ø mounting (mm)	connection (mm)	cable (mm)
1	100008	plastic	pushing	22	ø 2,0	-
2	100039	plastic	pushing	22	F 6,3x0,8	-
3	100111	plastic	pushing	22	F 6,3x0,8	-
4	105209	plastic	pushing	22	F 6,3x0,8	200
5	100115	locking ring M22x1				

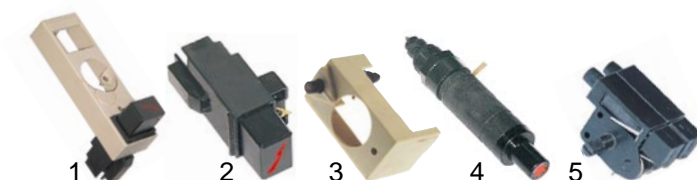

item	order no.	body	actuation	mounting dimensions (mm)	connection (mm)	cable (mm)
1	101136	plastic	pushing	27x36	F 6,3x0,8	-
2	100001	plastic	pushing	27x36	F 6,3x0,8	-
3	101358	plastic	pushing	ø 18	ø 2,4	-
4	100006	plastic	pushing	ø 18	ø 2,4	200
5	100114	plastic	rotary	-	ø 2,4	-

## ignition push buttons/ignition switches



item	order no.	description	ø mounting (mm)	connection (mm)
1	100010	1 CO	10	F 6,3x0,8
2	100038	1 CO	11	F 6,3x0,8
3	101029	1 NO	16	F 6,3x0,8
4	345038	2 NO	25	F 6,3x0,8
5	345039	protective cover for switch		



item	order no.	description	ø mounting (mm)	connection (mm)
1	301076	2 NO	30x22	F 6,3x0,8
2	345189	2 NO	30x22	F 6,3x0,8
3	301021	2 NO	30x22	F 6,3x0,8
4	100160	1 NO	28x28	F 6,3x0,8
5	301014	1 NO	30x11	F 6,3x0,8
6	101038	1 NO	-	F 2,8x0,8

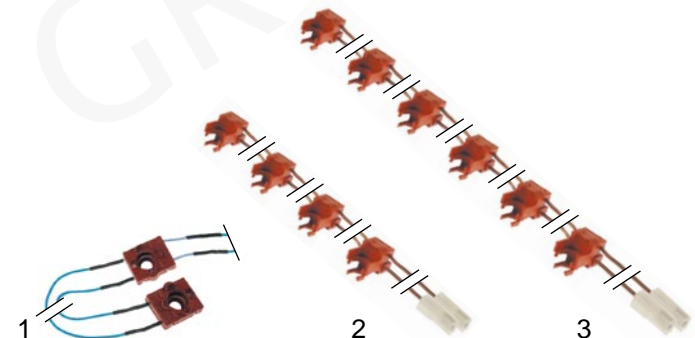

item	order no.	description
1	101033	ignition switch 2-fold for gas taps Sabaf
2	101039	ignition switch 4-fold for gas taps Sabaf
3	101035	ignition switch 6-fold for gas taps Sabaf



item	order no.	description	ø mounting (mm)	connection
1	301195	ignition switch	22	F 6,3x0,8mm/F 2,8x0,8mm
2	101036	battery holder	22	F 6,3x0,8mm/F 2,8x0,8mm
3	102909	battery holder	19	F 2,8x0,8mm

## ignition units

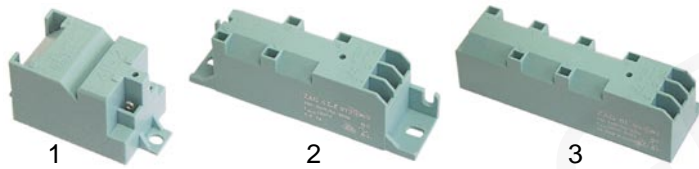

item	order no.	outputs	supply	ø mounting (mm)	connections (mm)		type
					input	output	
1	101012	2	230 VAC	56	F 2,8x0,8	F 2,8x0,8	ZIG 2
2	101023	4	230 VAC	98	F 6,3x0,8	F 2,8x0,8	ZAG 4
3	101024	6	230 VAC	98	F 6,3x0,8	F 2,8x0,8	ZAG 6



item	order no.	outputs	supply	ø mounting (mm)	connections (mm)	
					input	output
1	101002	2	230 VAC	73	F 6,3x0,8	F 2,8x0,8
	101009	2	1,5 VDC	73	F 6,3x0,8	F 2,8x0,8
2	102388	4	230 VAC	100	F 6,3x0,8	F 2,8x0,8
	101031	4	1,5 VDC	100	F 6,3x0,8	F 2,8x0,8
3	102389	6	230 VAC	122	F 6,3x0,8	F 2,8x0,8
	101032	6	1,5 VDC	122	F 6,3x0,8	F 2,8x0,8

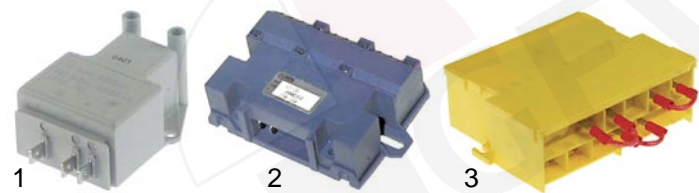

item	order no.	outputs	supply	ø mounting (mm)	connections (mm)	
					input	output
1	101016	2	230 VAC	42	F 6,3x0,8	F 2,8x0,8
2	101004	6	230 VAC	88	F 6,3x0,8	F 2,8x0,8
3	101008	8	230 VAC	103	F 6,3x0,8	F 2,8x0,8
	102908	8	1,5 VDC	103	F 6,3x0,8	F 2,8x0,8

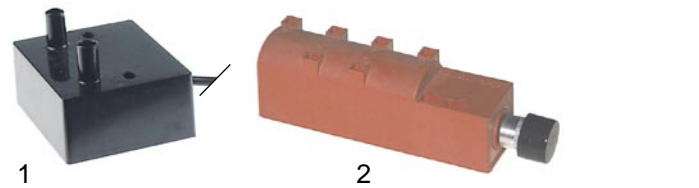

item	order no.	outputs	supply	ø mounting (mm)	connections	
					input	output
1	101017	2	230 VAC	60	cable	ø 4mm
2	101006	6	230 VAC	-	F 6,3x0,8	F 2,8x0,8

## ignition cables

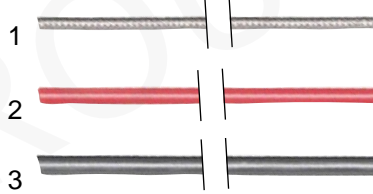

item	order no.	Qty (m)	nominal cross section (mm <sup>2</sup> )	colour	ø outer (mm)	material
1	100027	5	0,34	white	3	braided glass fibre
	102627	100	0,34	white	3	braided glass fibre
2	100120	5	1	white	3,9	silicone
	570630	100	1	white	3,9	silicone
3	100028	5	1	red	6,2	silicone
	102628	100	1	red	6,2	silicone



item	order no.	Qty (piece)	ø size (mm)	nominal cross section (mm <sup>2</sup> )
1	100112	20	ø 2,0	0,25-1,0
2	100023	20	ø 2,4	0,5-1,5
3	100024	20	ø 4,0	0,25-1,5
4	550923	20	ø 6,0	0,5-1,5
5	100021	20	F 2,8x0,8	0,5-1,0
6	100022	20	F 6,3x0,8	1,0-2,5
7	550945	20	ø 4,0	0,25-1,5



pos.	order no.	Qty (m)	description	ø size (mm)
1	100030	10	silicone	3x0,65
	570030	100		
2	100031	10	silicone	5x0,9
	570031	100		
3	100032	10	silicone	6x0,9
	570032	100		
4	100033	10	silicone	8x1,0
	570033	100		
5	100034	10	silicone	10x1,0
	570034	50		

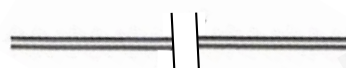

pos.	order no.	Qty (m)	description	diameter (mm)	
				ordinary	shrunk
1	100029	5	contracting tube	4,8	2,4
2	100035	5	contracting tube	6,4	3,2

## manufactured ignition cables

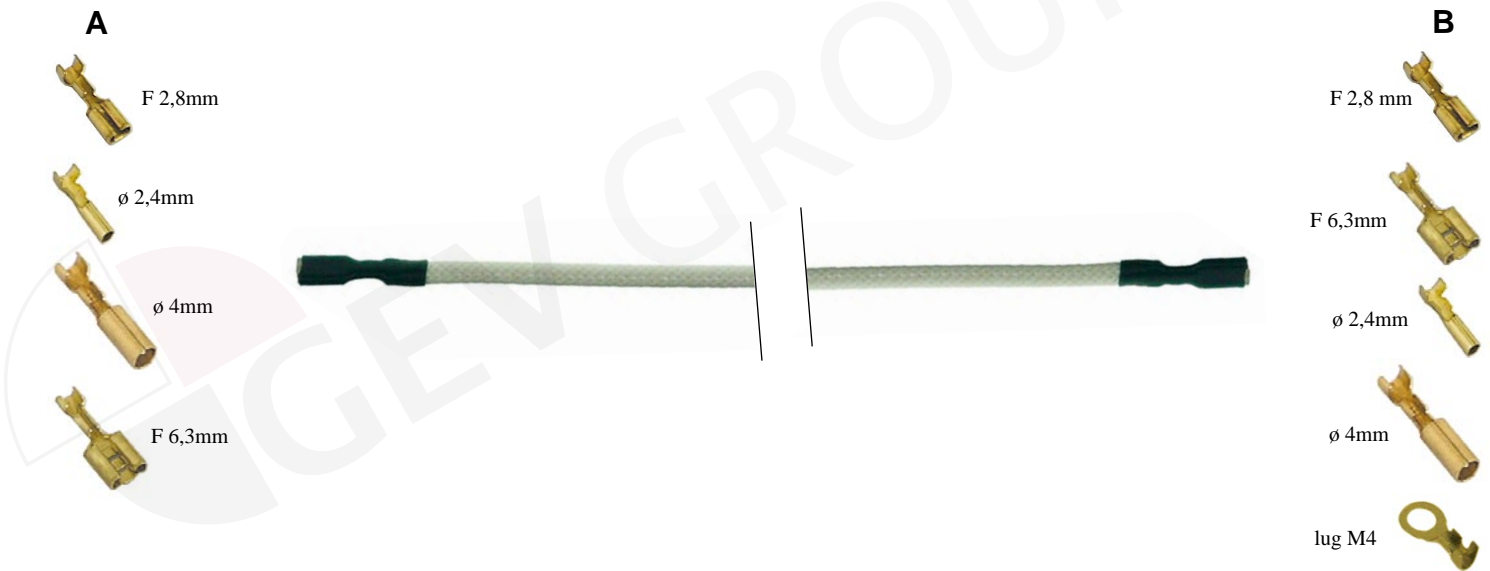

I  
Ignition components

pos.	order no.	length (mm)	connections		pos.	order no.	length (mm)	connections	
			page A (mm)	page B (mm)				page A (mm)	page B (mm)
1	102191	300	F 2,8	F 2,8	33	102311	2000	F 2,8	lug M4
2	100036	500	F 2,8	F 2,8	34	100014	300	ø 2,4	ø 2,4
3	102159	600	F 2,8	F 2,8	35	100015	600	ø 2,4	ø 2,4
4	100037	900	F 2,8	F 2,8	36	100016	900	ø 2,4	ø 2,4
5	100190	1200	F 2,8	F 2,8	37	102180	1200	ø 2,4	ø 2,4
6	100174	1500	F 2,8	F 2,8	38	102181	1500	ø 2,4	ø 2,4
7	102192	1750	F 2,8	F 2,8	39	102182	1750	ø 2,4	ø 2,4
8	102193	2000	F 2,8	F 2,8	40	102160	2000	ø 2,4	ø 2,4
9	102162	400	F 2,8	F 6,3	41	100017	300	ø 2,4	ø 4
10	102178	900	F 2,8	F 6,3	42	100140	400	ø 2,4	ø 4
11	102179	1200	F 2,8	F 6,3	43	100018	600	ø 2,4	ø 4
12	102188	300	F 2,8	ø 2,4	44	100019	900	ø 2,4	ø 4
13	100197	600	F 2,8	ø 2,4	45	100176	1000	ø 2,4	ø 4
14	100178	900	F 2,8	ø 2,4	46	100193	1200	ø 2,4	ø 4
15	100179	1200	F 2,8	ø 2,4	47	102150	1500	ø 2,4	ø 4
16	102163	1500	F 2,8	ø 2,4	48	100175	1750	ø 2,4	ø 4
17	102183	1750	F 2,8	ø 2,4	49	100194	1900	ø 2,4	ø 4
18	100191	2000	F 2,8	ø 2,4	50	100137	2000	ø 2,4	ø 4
19	102187	300	F 2,8	ø 4	51	102189	300	ø 2,4	lug M4
20	100199	600	F 2,8	ø 4	52	100166	500	ø 2,4	lug M4
21	102155	900	F 2,8	ø 4	53	100186	600	ø 2,4	lug M4
22	100164	1200	F 2,8	ø 4	54	100146	900	ø 2,4	lug M4
23	102190	1500	F 2,8	ø 4	55	100195	1200	ø 2,4	lug M4
24	102158	1750	F 2,8	ø 4	56	102184	1500	ø 2,4	lug M4
25	102174	2000	F 2,8	ø 4	57	102185	1750	ø 2,4	lug M4
26	100189	150	F 2,8	lug M4	58	102186	2000	ø 2,4	lug M4
27	102194	300	F 2,8	lug M4	59	102172	300	ø 4	F 6,3
28	102156	600	F 2,8	lug M4	60	100025	600	ø 4	F 6,3
29	102195	900	F 2,8	lug M4	61	100026	1000	ø 4	F 6,3
30	102157	1200	F 2,8	lug M4	62	102270	1500	ø 4	F 6,3
31	102196	1500	F 2,8	lug M4	63	102177	600	F 6,3	lug M4
32	102310	1750	F 2,8	lug M4	64	102164	1000	F 6,3	lug M4

## universal thermocouples

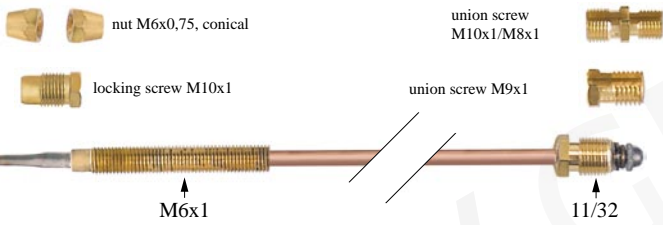

pos.	order no.	description	length (mm)
1	102005	thermocouple set 6-piece	600
2	102000	thermocouple set 6-piece	900
3	102006	thermocouple set 6-piece	1200

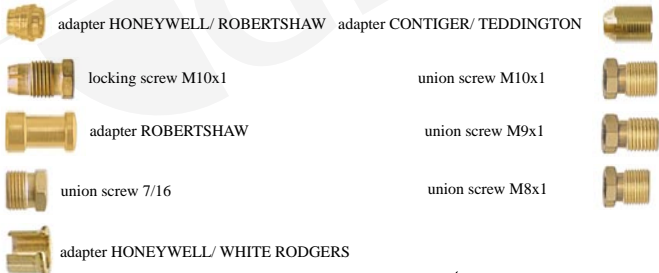

pos.	order no.	description	length (mm)
1	102129	thermocouple set 10-piece	600
2	102130	thermocouple set 10-piece	900



pos.	order no.	description	length (mm)
1	102003	thermocouple set 10-piece	900
2	102002	thermocouple set 10-piece	1200

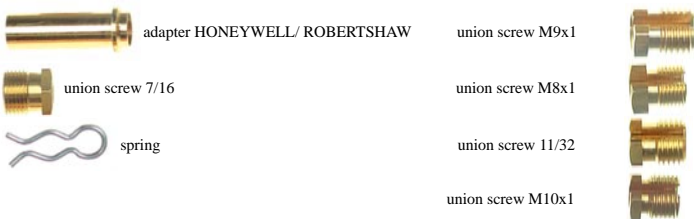

pos.	order no.	description	length (mm)
1	102284	thermocouple set 8-piece	900

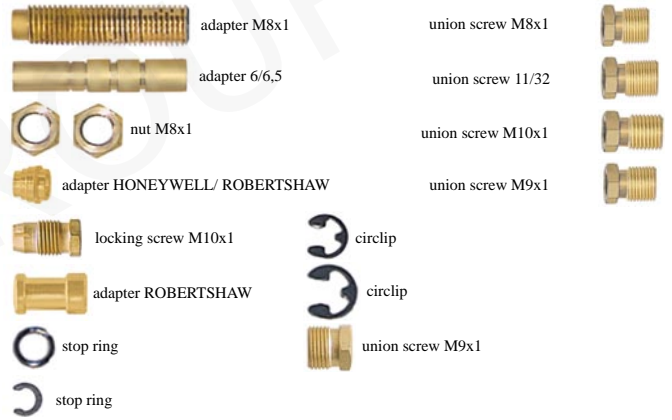

pos.	order no.	description	length (mm)
1	102001	thermocouple set 17-piece	900
2	102004	thermocouple set 17-piece	1200

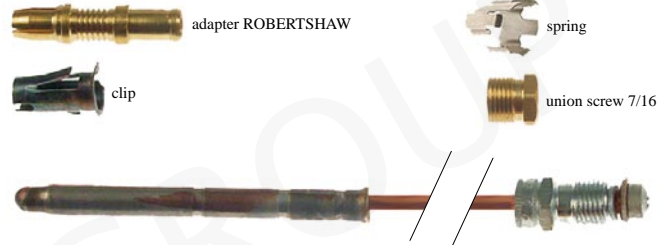

pos.	order no.	description	length (mm)
1	102280	thermocouple set 5-piece	450
2	102281	thermocouple set 5-piece	600
3	102282	thermocouple set 5-piece	900
4	102283	thermocouple set 5-piece	1800

## universal flexible thermocouples

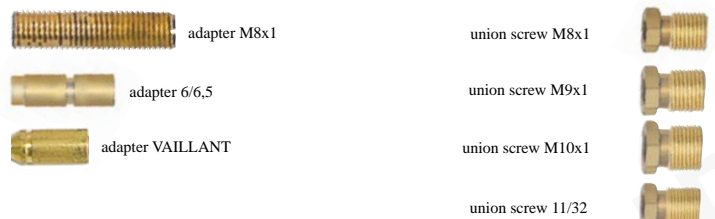

pos.	order no.	description	length (mm)
1	102285	thermocouple set 8-piece	600
2	102286	thermocouple set 8-piece	900
3	102287	thermocouple set 8-piece	1200

## bare thermocouples (must have fittings to operate)

### bare thermocouples type SEF (flexible)

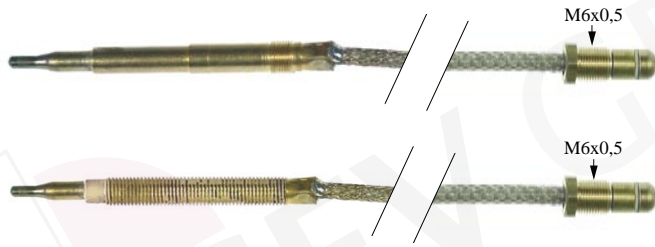

item	order no.	length (mm)	type	item	order no.	length (mm)	type
1	102023	600	SEF1	2	102435	600	SEF2
	102024	900	SEF1		102436	900	SEF2
	102025	1200	SEF1		102437	1200	SEF2

- 1 adapter M8x1
- 2 adapter 6/6,5mm
- 3 adapter HONEYWELL/  
ROBERTSHAW
- 4 adapter VAILLANT
- 5 adapter JUNKERS
- 6 adapter ITT
- 7 adapter ITT
- 8 union screw 7/16
- 9 nut M8x1
- 10 nut M6x0,75
- 11 nut M6x0,75 conical
- 12 locking screw M10x1/6,5mm
- 13 locking screw  
M10x1/6mm
- 14 locking screw  
M10x1/6,5mm  
(RÜCKELSHAUSEN)
- 15 scalped washer
- 16 tightening rod
- 17 intermediate ring SIT/TARGET
- 18 adapter VAILLANT
- 19 duct
- 20 adapter M8x1
- 21 adapter M9x1
- 22 adapter M10x1
- 23 adapter 11/32

item	order no.	Qty (piece)	type	item	order no.	Qty (piece)	type
1	100914	1	SEF1	13	102677	1	SEF2
	102714	5		14	102678	1	SEF2
2	100915	1	SEF1	15	102666	1	SEF1
	102715	5		16	102668	1	SEF1
3	102673	1	SEF1	17	102669	1	SEF1
4	102670	1	SEF1	18	102671	1	SEF1
5	102667	1	SEF1	19	102672	1	SEF1
6	102675	1	SEF1	20	100910	1	SEF1/2
7	102679	1	SEF2	102710	5		
8	102674	1	SEF1	21	100911	1	SEF1/2
9	102067	1	SEF1	102711	5		
10	102680	1	SEF1/2	22	100912	1	SEF1/2
11	101297	1	SEF2	102712	5		
12	100907	1	SEF1	23	100913	1	SEF1/2
	102507	5		102713	5		

### bare thermocouples type GF (flexible)



pos.	order no.	length (mm)	pos.	order no.	length (mm)
1	102248	400	3	102098	900
2	102097	600	4	102099	1200

### accessories for bare thermocouples type GF

- 1 adapter M8x1
- 2 adapter 6/6,5mm
- 3 adapter M8x1
- 4 adapter M9x1
- 5 adapter M10x1
- 6 adapter 11/32

item	order no.	Qty (piece)	item	order no.	Qty (piece)	item	order no.	Qty (piece)
1	100935	1	3	100930	1	5	100932	1
	102735	5		102730	5		102732	5
2	100934	1	4	102931	1	6	100933	1
	102734	5		102731	5		102733	5

## standard thermocouples

### thermocouples 5mm

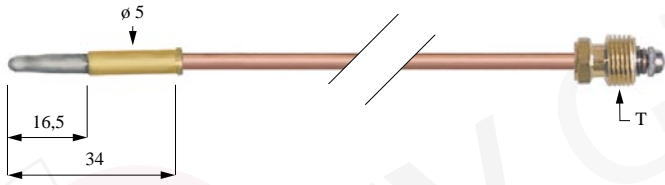

pos.	order no.	length (mm)	T	pos.	order no.	length (mm)	T
1	102201	220	M8x1	10	102251	750	M9x1
2	102202	320	M8x1	11	102210	220	M10x1
3	102203	450	M8x1	12	102211	320	M10x1
4	102204	600	M8x1	13	102212	450	M10x1
5	102205	750	M8x1	14	102213	600	M10x1
6	102206	850	M8x1	15	102214	750	M10x1
7	102207	1000	M8x1	16	102132	1000	M10x1
8	102208	1200	M8x1	17	102215	1200	M10x1
9	102209	1500	M8x1	18	102216	1500	M10x1

### thermocouples 5mm flexible

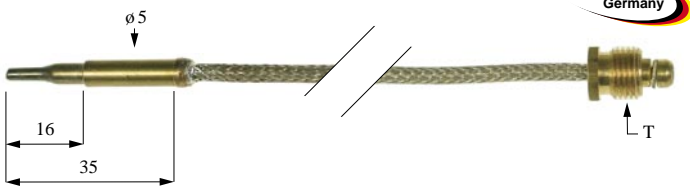

pos.	order no.	length (mm)	T	pos.	order no.	length (mm)	T
1	102390	600	M8x1	4	102393	600	M10x1
2	102391	900	M8x1	5	102394	900	M10x1
3	102392	1200	M8x1	6	102395	1200	M10x1

### thermocouples 6mm

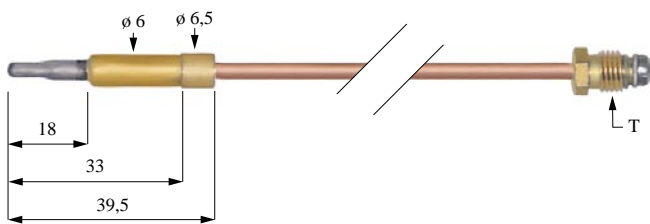

pos.	order no.	length (mm)	T	pos.	order no.	length (mm)	T
1	102217	220	M8x1	9	102226	450	M10x1
2	102218	320	M8x1	10	102227	600	M10x1
3	102219	450	M8x1	11	102228	750	M10x1
4	102220	600	M8x1	12	102229	1000	M10x1
5	102221	750	M8x1	13	102230	1200	M10x1
6	102223	1200	M8x1	14	102231	1500	M10x1
7	102224	1500	M8x1	15	102256	1000	11/32
8	102225	320	M10x1				

### thermocouples 6mm flexible

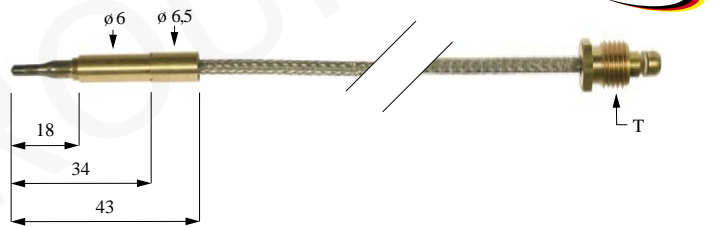

pos.	order no.	length (mm)	T	pos.	order no.	length (mm)	T
1	102396	600	M8x1	4	102399	600	M10x1
2	102397	900	M8x1	5	102400	900	M10x1
3	102398	1200	M8x1	6	102401	1200	M10x1

### thermocouples 6/6,5mm

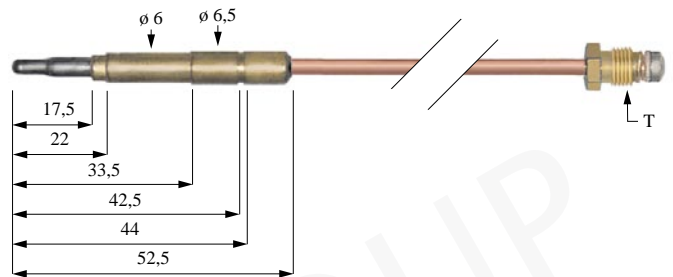

pos.	order no.	length (mm)	T	pos.	order no.	length (mm)	T
1	102033	320	M8x1	14	102007	320	M10x1
2	102034	600	M8x1	15	102071	400	M10x1
3	102035	850	M8x1	16	102075	600	M10x1
4	102036	1000	M8x1	17	102076	850	M10x1
5	102037	1200	M8x1	18	102072	1000	M10x1
6	102038	1500	M8x1	19	102077	1500	M10x1
7	102039	320	M9x1	20	102046	400	11/32
8	102040	500	M9x1	21	102047	600	11/32
9	102041	600	M9x1	22	102048	850	11/32
10	102042	850	M9x1	23	102049	1000	11/32
11	102043	1000	M9x1	24	102051	1500	11/32
12	102044	1200	M9x1				
13	102045	1500	M9x1				

### thermocouples 6/6,5mm flexible

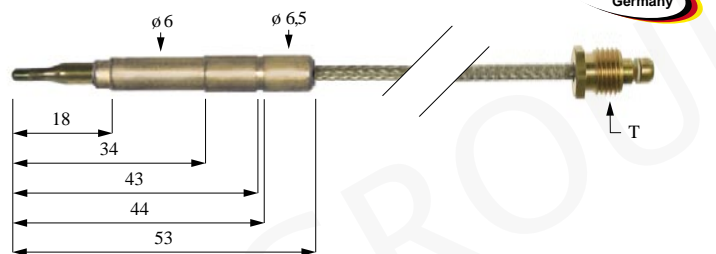

pos.	order no.	length (mm)	T	pos.	order no.	length (mm)	T
1	102402	600	M8x1	4	102407	1200	M9x1
2	102403	900	M8x1	5	102408	600	M10x1
3	102404	1200	M8x1	6	102409	900	M10x1
4	102405	600	M9x1	7	102410	1200	M10x1
5	102406	900	M9x1				



## threaded thermocouples M8x1

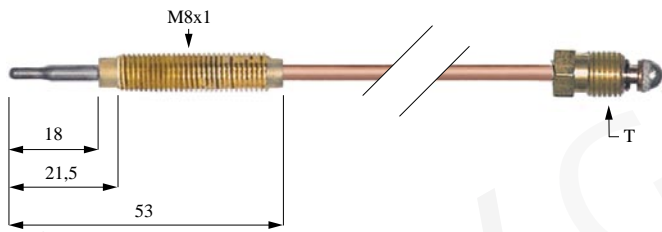

pos.	order no.	length (mm)	T	pos.	order no.	length (mm)	T
1	102232	220	M8x1	12	102063	850	M9x1
2	102054	320	M8x1	13	102064	1000	M9x1
3	102055	450	M8x1	14	102065	1200	M9x1
4	102056	600	M8x1	15	102066	1500	M9x1
5	102233	750	M8x1	16	102073	400	M10x1
6	102057	850	M8x1	17	102235	450	M10x1
7	102058	1000	M8x1	18	102078	600	M10x1
8	102059	1200	M8x1	19	102079	750	M10x1
9	102060	1500	M8x1	20	102074	1000	M10x1
10	102061	320	M9x1	21	102080	1500	M10x1
11	102062	600	M9x1				

## thermocouples ROBERTSHAW, flexible

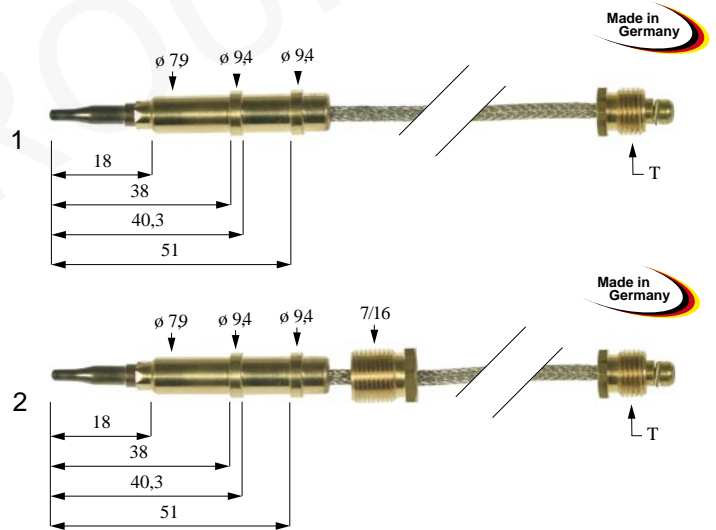

item	order no.	length (mm)	T	item	order no.	length (mm)	T
	102429	600	11/32		102432	600	11/32
1	102430	900	11/32	2	102433	900	11/32
	102431	1200	11/32		102434	1200	11/32

## threaded thermocouples M8x1 flexible

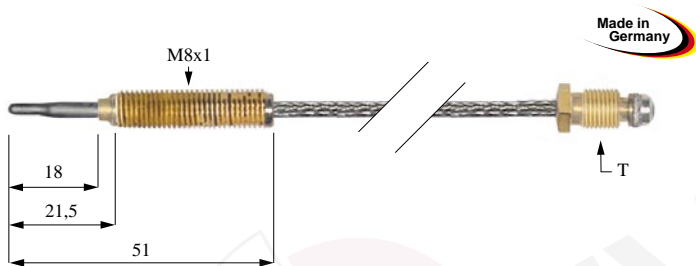

pos.	order no.	length (mm)	T	pos.	order no.	length (mm)	T
1	102136	220	M8x1	7	102415	900	M9x1
2	102128	320	M8x1	8	102416	1200	M9x1
3	102411	600	M8x1	9	102417	600	M10x1
4	102412	900	M8x1	10	102418	900	M10x1
5	102413	1200	M8x1	11	102419	1200	M10x1
6	102414	600	M9x1				

## thermocouples HONEYWELL

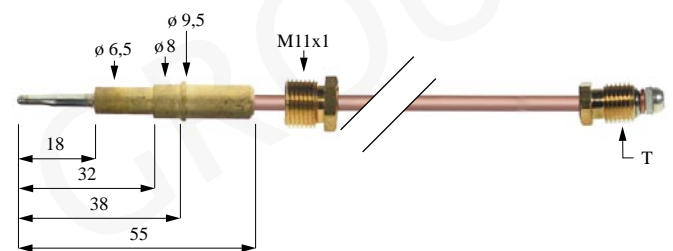

pos.	order no.	length (mm)	T
1	102893	1000	11/32

## thermocouples ROBERTSHAW

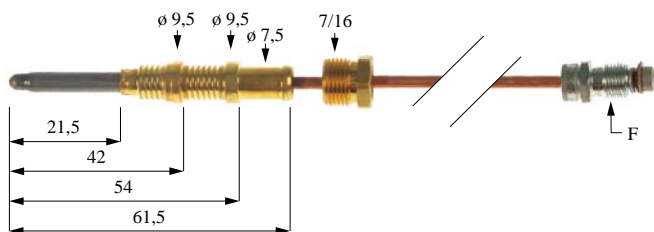

pos.	order no.	length (mm)	T	pos.	order no.	length (mm)	T
1	102122	450	11/32	4	102277	900	11/32
2	102276	600	11/32	5	102278	1200	11/32
3	102123	750	11/32	6	102279	1800	11/32

## thermocouples with nickeled cables

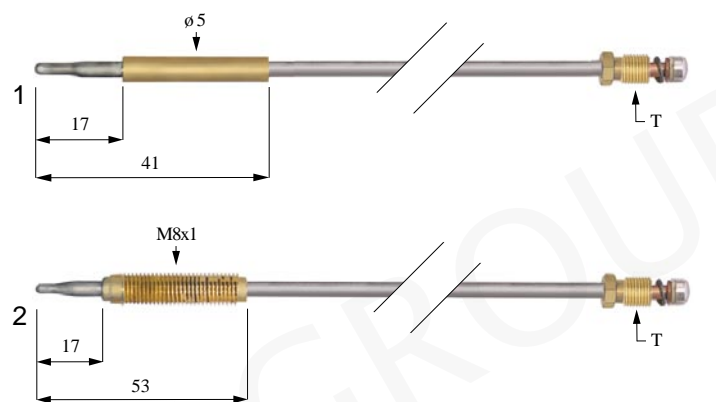

item	order no.	length (mm)	T	item	order no.	length (mm)	T
1	102112	450	M8x1	2	102113	450	M8x1

## various thermocouples

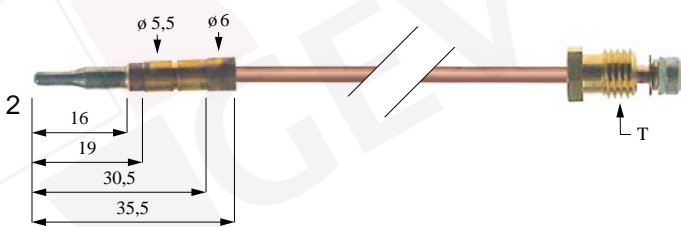
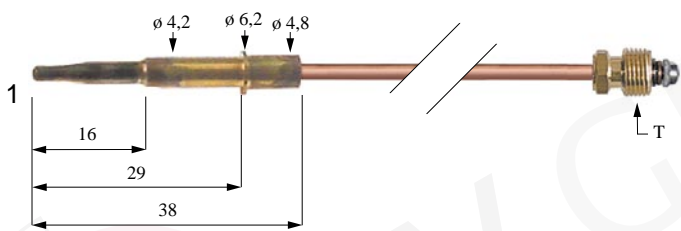

item	order no.	length (mm)	T	item	order no.	length (mm)	T
1	102261	600	M8x1	2	102258	600	M8x1

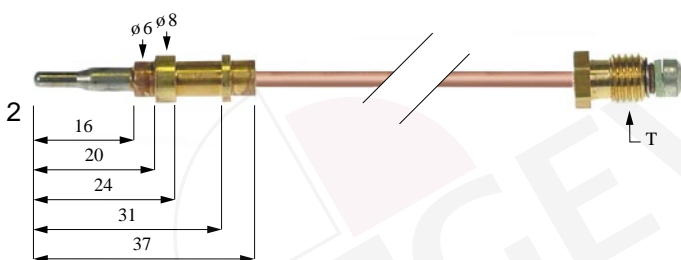
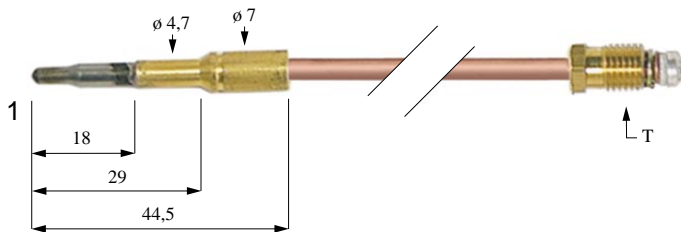

item	order no.	length (mm)	T	item	order no.	length (mm)	T
1	102125	420	M8x1	2	102266	220	M8x1

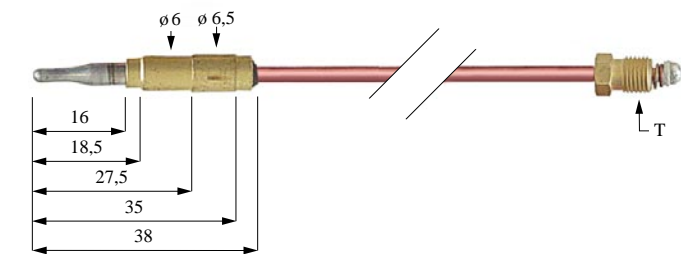

pos.	order no.	length (mm)	T	pos.	order no.	length (mm)	T
1	102246	600	M9x1	3	102267	850	M8x1
2	102923	750	M9x1				

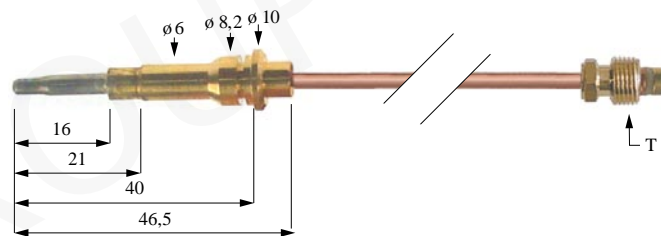

pos.	order no.	length (mm)	T	pos.	order no.	length (mm)	T
1	102262	1200	M8x1	2	102263	1400	M8x1

## various thermocouples flexible

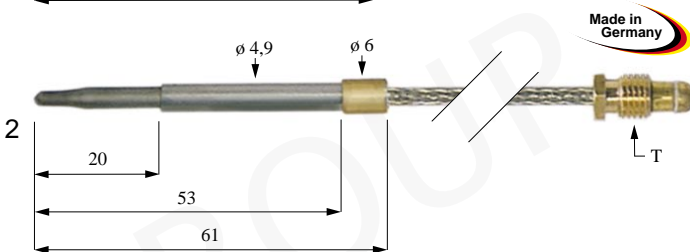
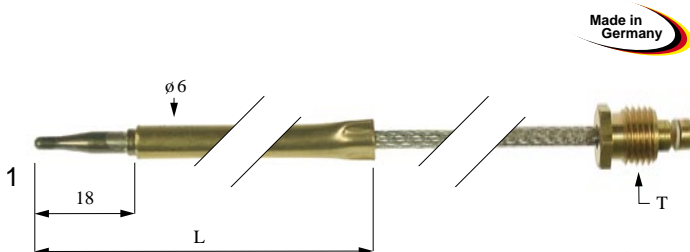

item	order no.	length (mm)	L (mm)	T	item	order no.	length (mm)	L (mm)	T
1	102422	650	60	M10x1	1	102424	650	115	M10x1
	102423	650	95	M10x1	2	102119	320	-	M8x1

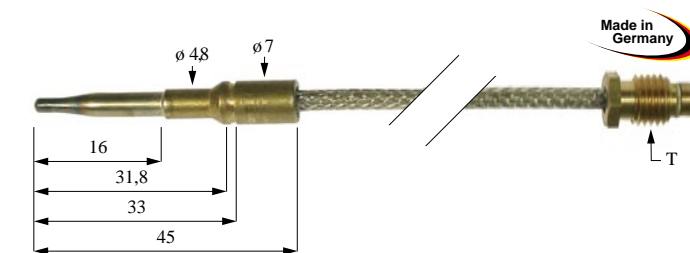

pos.	order no.	length (mm)	T
1	102428	450	M8x1

## various threaded thermocouples

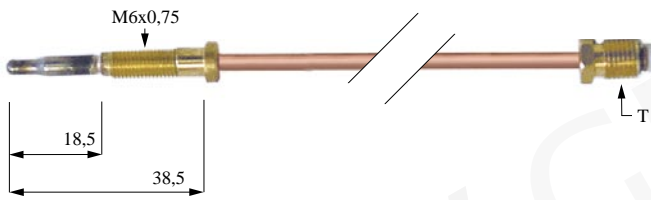

pos.	order no.	length (mm)	T	pos.	order no.	length (mm)	T
1	102138	300	M9x1	2	102139	500	M9x1

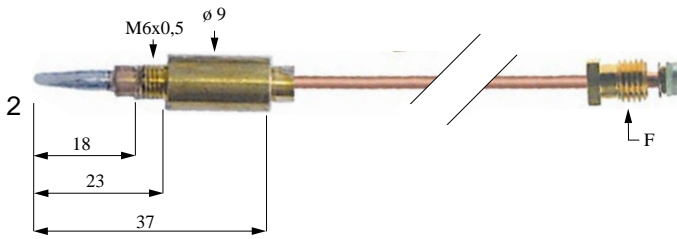
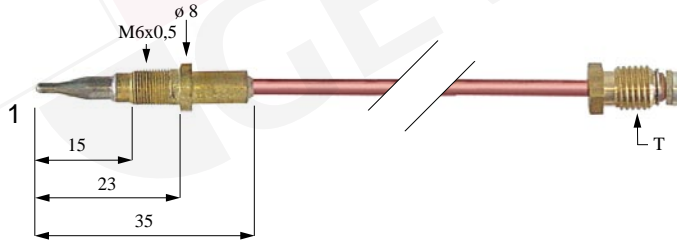

item	order no.	length (mm)	T	item	order no.	length (mm)	T
1	102245	500	M8x1	2	102121	600	M8x1

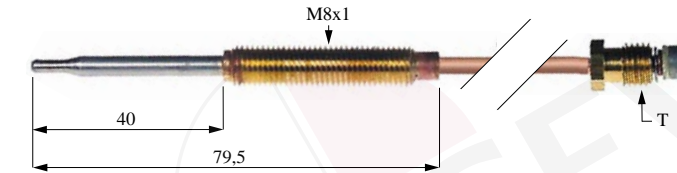

pos.	order no.	length (mm)	T
1	102249	250	M8x1

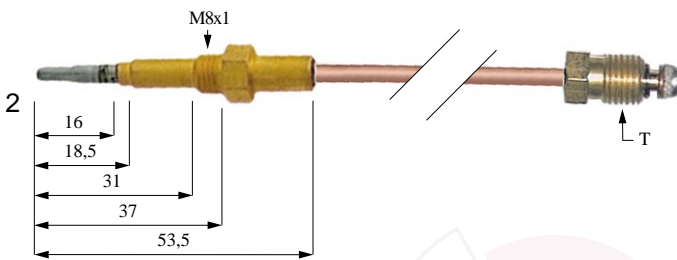
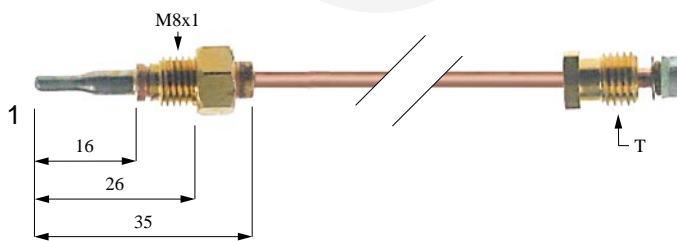

item	order no.	length (mm)	T	item	order no.	length (mm)	T
1	102257	600	M8x1	2	102008	1000	M9x1

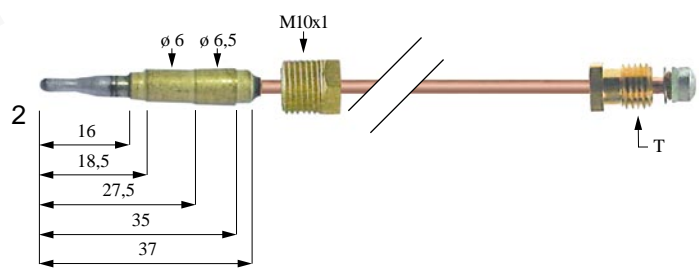
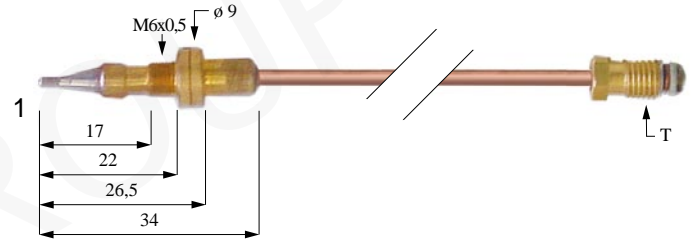

item	order no.	length (mm)	T	item	order no.	length (mm)	T
1	102153	600	M8x1	2	102944	1500	M9x1

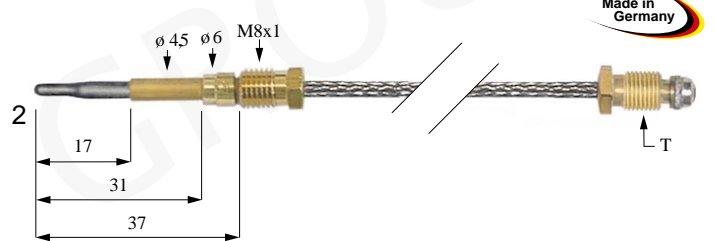
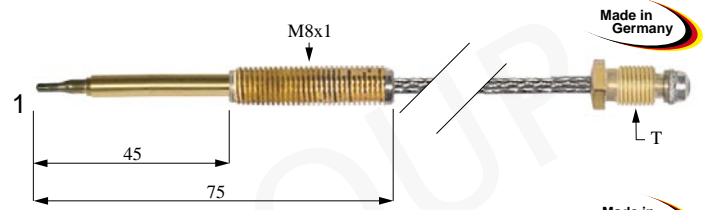

item	order no.	length (mm)	T	item	order no.	length (mm)	T
1	102420	750	M8x1	2	102114	900	M8x1
	102421	750	M10x1				

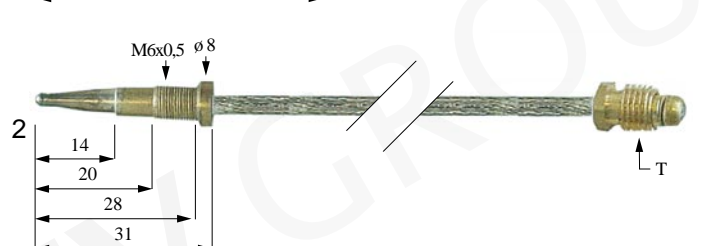
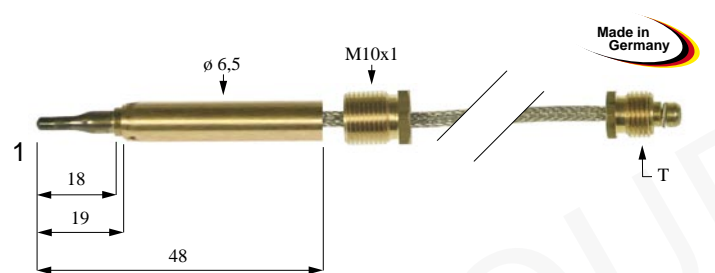

item	order no.	length (mm)	T	item	order no.	length (mm)	T
1	102425	600	11/32	1	102427	1200	11/32
	102426	900	11/32	2	102244	500	M8x1

## thermocouples with one conductor

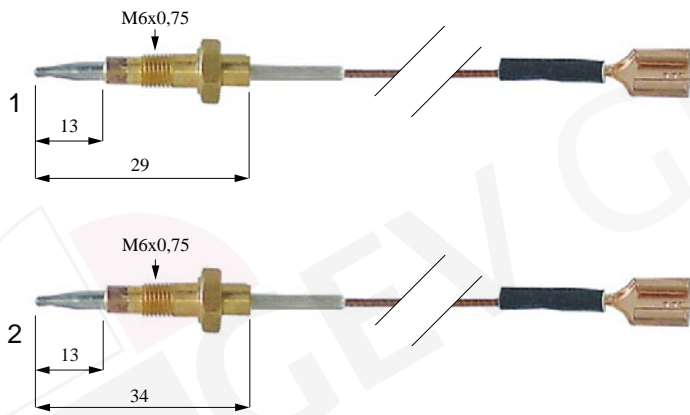

item	order no.	length (mm)	connection	item	order no.	length (mm)	connection
1	102145	600	F 7,7mm	2	102242	750	F 7,7mm

## thermocouples with two conductors



pos.	order no.	length (mm)	T
1	102089	600	M8x1
2	102131	1000	M8x1



pos.	order no.	length (mm)		A	connections B
		phase conductor (L1)	ground cable (L2)		
1	102255	600	600	lug M5	F 6,3mm
2	102814	1000	1100	lug M5	F 6,3mm

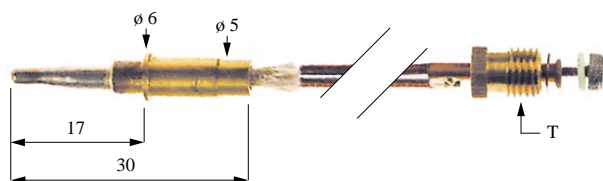

pos.	order no.	length (mm)	T
1	102260	600	M8x1

## threaded thermocouples with two conductors

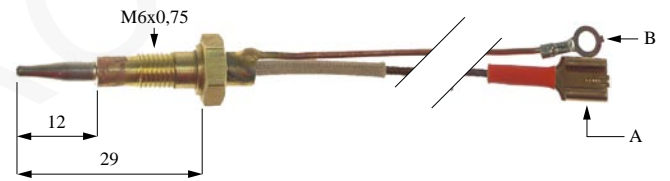

pos.	order no.	length (mm)		A	connections B
		phase conductor (L1)	ground cable (L2)		
1	102271	600	600	F 7,7mm	lug M4
2	102148	600	100	F 7,7mm	F 2,8x08mm

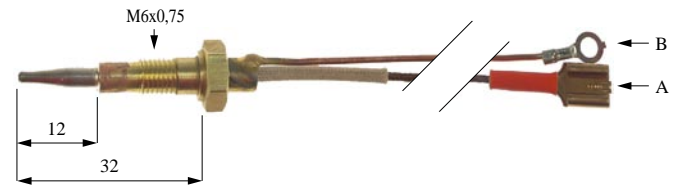

pos.	order no.	length (mm)		A	connections B
		phase conductor (L1)	ground cable (L2)		
1	102147	750	100	F 7,7mm	F 2,8x08mm
2	102924	750	750	F 7,7mm	lug M4

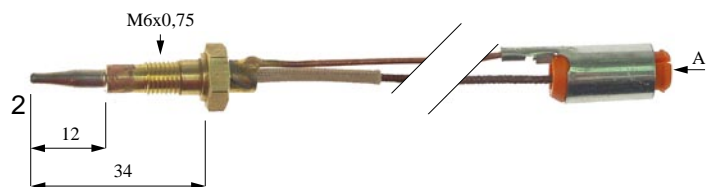
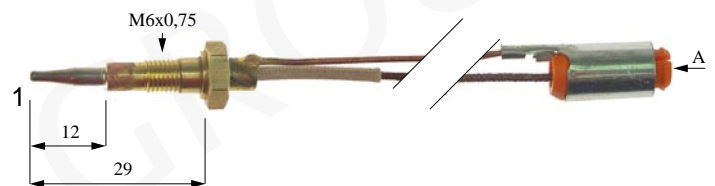

item	order no.	length (mm)	connection	item	order no.	length (mm)	connection
1	102127	600	ø 2mm	2	102152	750	ø 2mm

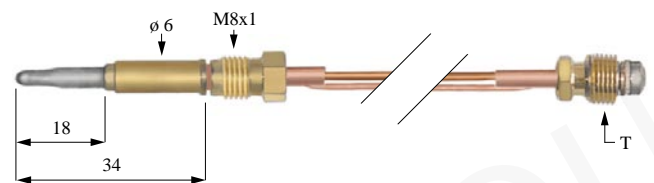

pos.	order no.	length (mm)	T
1	102088	1500	M10x1

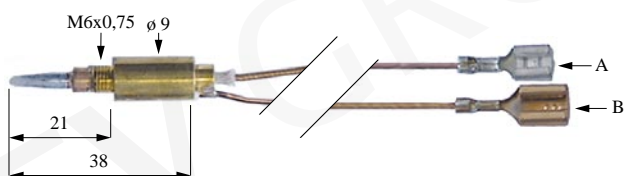

pos.	order no.	length (mm)		A	connections B
		phase conductor (L1)	ground cable (L2)		
1	102120	750	750	F 7,7mm	F 6,3mm

## thermocouples with interruption

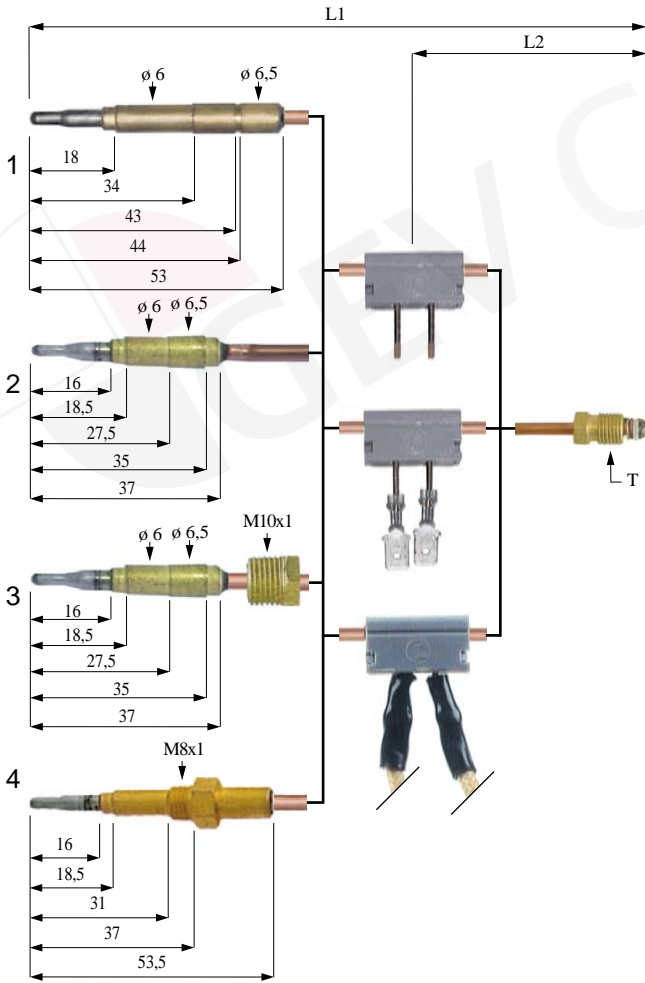

item	order no.	L1 (mm)	L2 (mm)	T	connection
1	102068	320	130	M9x1	solder connection
	102069	600	130	M9x1	solder connection
	102070	1000	130	M9x1	solder connection
	102247	600	130	M9x1	with cable 600mm
	102250	1000	130	M9x1	with cable 1000mm
2	100172	400	180	11/32	Faston 6,3mm
	102238	600	130	M9x1	Faston 6,3mm
3	102252	600	130	M9x1	with cable 650mm
	102254	1000	130	M9x1	solder connection
4	102259	1000	130	M9x1	with cable 1000mm

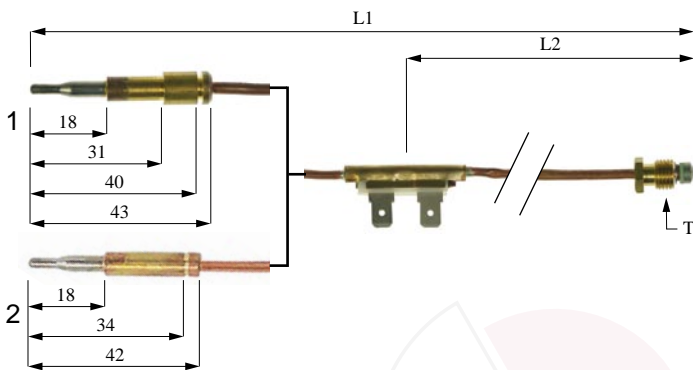

item	order no.	L1 (mm)	L2 (mm)	T	connection
1	102269	850	180	M9x1	F 6,3mm
2	102124	850	180	M8x1	F 6,3mm

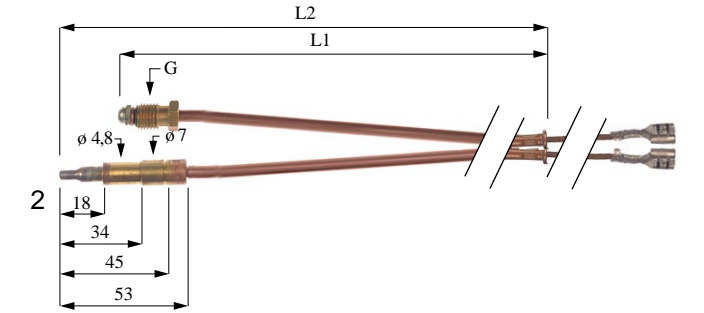
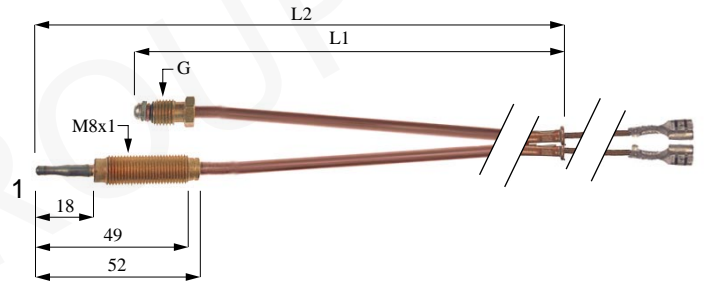

item	order no.	L1 (mm)	L2 (mm)	T	connection
1	102239	500	300	M8x1	with cable 250mm F 6,3mm
2	102115	500	200	M9x1	with cable 400mm F 6,3mm

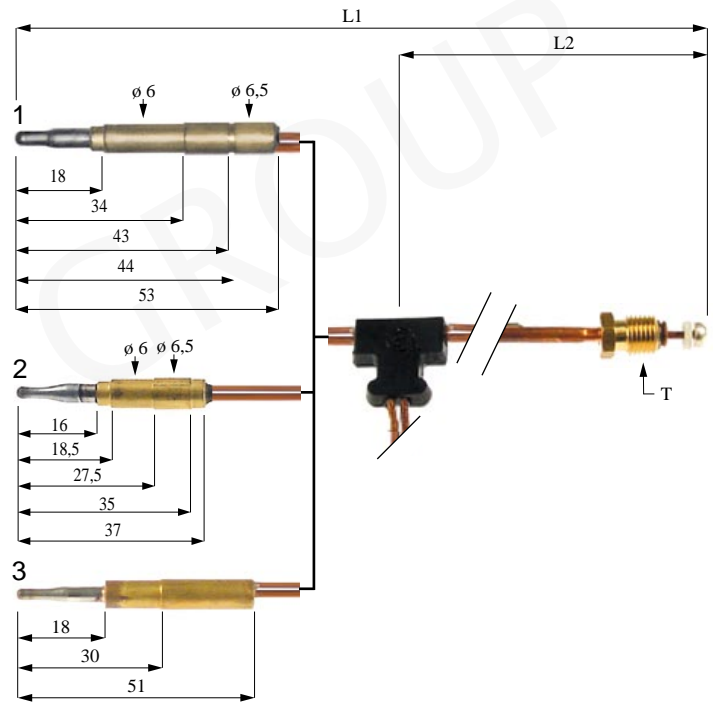

item	order no.	L1 (mm)	L2 (mm)	T	connection
1	102925	750	200	M9x1	with cable 300mm F 6,3mm
2	102094	750	200	M9x1	with cable 300mm F 6,3mm
3	102812	1000	150	M9x1	with cable 600mm F 6,3mm

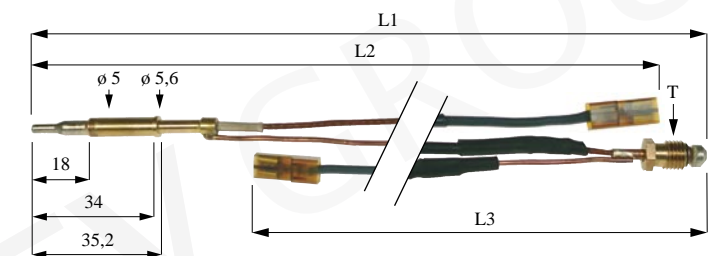

pos.	order no.	L1 (mm)	L2 (mm)	L3 (mm)	T	connection
1	102815	1000	650	550	M8x1	F 6,3mm

## thermoelectric generators (system mV)

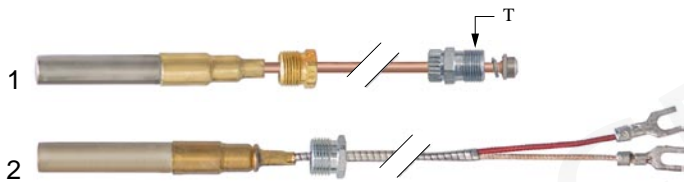

item	order no.	length (mm)	T	item	order no.	length (mm)
1	580035	820	3/8" NEF	2	102116	600

## extensions for thermocouples

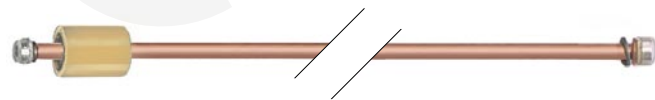

pos.	order no.	length (mm)	T	pos.	order no.	length (mm)	T
1	102011	400	M10x1	5	102012	1000	M10x1
2	102013	500	M9x1	6	102852	1500	M9x1
3	102811	600	M9x1	7	102010	1500	M10x1
4	102851	1000	M9x1				

## extensions for thermocouples, flexible



pos.	order no.	length (mm)	T
1	102241	500	M9x1

## accessories for thermocouples



item	order no.	Qty (piece)	description	suitable for
1	102067	1	nut M8x1	MKN
	102500	10		
2	100965	1	nut M8x1	MKN
3	104250	1	nut M8x1	Küppersbusch
4	102143	1	nut M6x0,75	MBM
5	102680	1	nut M6x0,75	
6	101297	1	nut M6x0,75	



item	order no.	Qty (piece)	description
1	100861	1	screw connection
2	101860	1	nut M10x1
3	100907	1	screw M10x1
	102507	5	
4	101295	1	sleeve 5mm
	102595	10	

## union screw

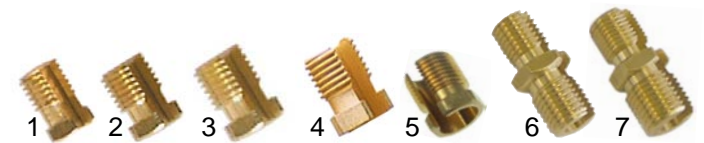

item	order no.	Qty (piece)	description	item	order no.	Qty (piece)	description
1	101260	1	M8x1	5	106112	1	7/16mm
	102566	10		6	100920	1	M8x1/M9x1
2	101261	1	M9x1	7	102720	5	M10x1, 11/32mm
	102561	10					
3	101262	1	M10x1		100922	1	
	102562	10			102722	5	
4	101263	1	11/32mm				
	102563	5					

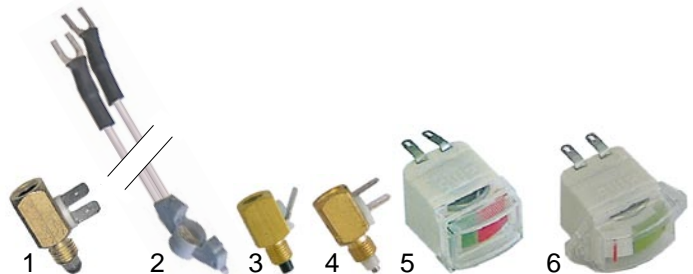

item	order no.	description
1	101264	interrupter M8x1
	101265	interrupter M9x1
	101258	interrupter M10x1
	101266	interrupter 11/32mm
2	580046	interrupter
3	100947	display adapter M8x1
	100948	display adapter M10x1
4	101337	display adapter M9x1
5	101414	display
6	101410	display



