



# ***HOT PLATES***

## *Heating elements and accessories*

### *Large hot plate heating elements, hot plates and radiation heaters*



### *Accessories*

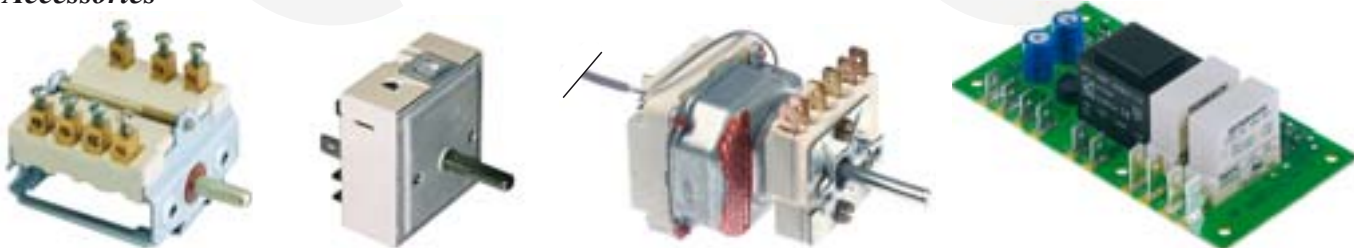

### *EGOTHERM heating plates*



**GEV Großküchen-Ersatzteil-Vertrieb GmbH**  
Robert-Koch-Straße 3a  
82152 Planegg/Munich  
Germany

Phone: +49 (0)89 745572-0  
Fax: +49 (0)89 745572-83  
order@gev-online.com  
www.gev-online.com

**Member of the GEV GROUP**

## Automatic hot plates



page 4

## Hot plates round



page 4

## Hot plates square



page 5

## Hot plates rectangular



page 6

## Heating elements for large hot plates



page 7

## Radiation heaters round



page 9

## Radiation heaters octagonal



page 9

## Radiation heaters square



page 10

## Radiation heaters rectangular



page 10

## Accessories



page 12

## EGOTHERM heating plates

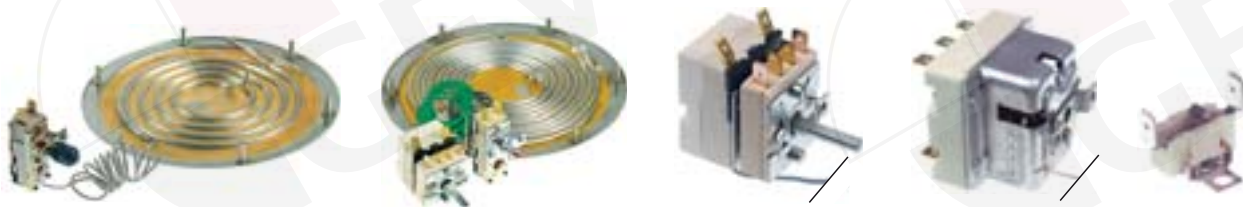

page 18

## automatic hot plates 4mm spill ring (domestic) with bolt fixing



pos.	order no.	ø (mm)	power	voltage	ref. no.
1	490036	145	1500W	230V	13.14356.020 13.14356.040

## automatic hot plates 8mm spill ring (domestic) with bolt fixing



pos.	order no.	ø (mm)	power	voltage	ref. no.
1	490033	145	1500W	230V	12.14356.234 12.14356.232
2	490023	180	2000W	230V	12.18356.234 12.18356.232

### with strap fixing



pos.	order no.	ø (mm)	power	voltage	ref. no.
1	490034	145	1500W	230V	12.14356.174 12.14356.172
2	490035	180	2000W	230V	12.18356.174 12.18356.172

## automatic hot plates replacement kit 8mm spill ring (domestic) with bolt fixing



pos.	order no.	ø (mm)	power	voltage	ref. no.
1	490059	145	1500W	230V	17.99014.112
2	490060	180	2000W	230V	17.99018.112

## automatic hot plates thermostats

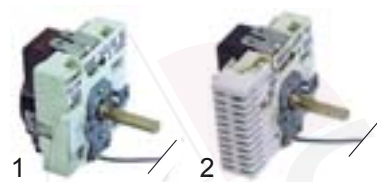

item	order no.	description	ref. no.
1	390401	capillary 600mm	76.01122.000
1	390402	capillary 1500mm	76.01125.000
2	390403	capillary 1500mm	76.03115.000

## hot plates round 4mm spill ring (domestic)



pos.	order no.	ø (mm)	power	voltage	connections	ref. no.
1	490001	145	1000W	230V	4	13.14453.040 13.14453.020
2	490004*	145	1500W	230V	4	13.14463.040 13.14454.040 13.14474.040 13.14463.020
3	490002	180	1500W	230V	4	13.18453.040 13.18453.020
4	490006*	180	2000W	230V	4	13.18463.040 13.18454.040 13.18474.040 13.18463.020
5	490003	220	2000W	230V	4	13.22453.040 13.22456.020

\* with protector

## hot plates round 8mm spill ring (commercial and domestic)



pos.	order no.	ø (mm)	power	voltage	connections	ref. no.
1	416191	90	450W	230V	3	12.08353.017
2	490010	145	1000W	230V	4	12.14453.194 12.14453.022
3	490011	145	1000W	400V	4	12.14453.025 12.14453.021
4	490012*	145	1500W	230V	4	12.14463.196 12.14463.022
5	490013*	145	1500W	400V	4	12.14463.197 12.14463.021
6	490014	180	1500W	230V	4	12.18453.196 12.18453.022
7	490129*	180	1500W	230V	4	12.18474.140
8	490015	180	1500W	400V	4	12.18453.025 12.18453.021
9	490016*	180	2000W	230V	4	12.18463.194 12.18463.022
10	490017*	180	2000W	400V	4	12.18463.198 12.18463.021
11	490018	220	2000W	230V	4	12.22453.199 12.22453.022
12	490130*	220	2000W	230V	4	12.22474.140
13	490019	220	2000W	400V	4	12.22453.025 12.22453.021
14	490174	220	2000W	440V	4	12.22453.018
15	490020*	220	2600W	230V	4	12.22463.018 12.22463.012
16	490021*	220	2600W	400V	4	12.22463.019 12.22463.011
17	490175*	220	2600W	440V	4	12.22463.014
18	490061	300	2500W	230V	4	12.30453.194
19	490063	300	2500W	400V	4	12.30453.195
20	490062*	300	3500W	230V	4	12.30454.194
21	490064*	300	3500W	400V	4	12.30454.195

\* with protector

## hot plates round (commercial kitchens) with screw mounting



item	order no.	ø (mm)	power	voltage	connections	ref. no.
1a	490106	400	5000W	400V	2x3	12.40670.231
1b	490107	400	5000W	400V	4x2	12.40870.007 12.40870.001

### with 2 bent connections



pos.	order no.	ø (mm)	power	voltage	connections	ref. no.
1	490103	400	5000W	400V	2x3	12.40650.001 12.40650.011

## hot plates square with spill ring (commercial kitchens)



pos.	order no.	measures (mm)	power	voltage	connections	ref. no.
1	490065	220x220	2000W	230V	4	11.22473.234 11.22473.232 11.22454.234
2	490067	220x220	2000W	400V	4	11.22473.235 11.22473.231 11.22454.235
3	490066*	220x220	2600W	230V	4	11.22454.237 11.22454.232
4	490068*	220x220	2600W	400V	4	11.22454.238 11.22454.231
5	490176*	220x220	2600W	440V	4	11.22454.264
6	490054*	300x300	2500W	230V	4	11.33473.238 11.33454.252 11.33454.232
7	490128*	300x300	2500W	400V	4	11.33473.231 11.33454.251 11.33454.231
8	490070	300x300	3000W	230V	4	11.33473.239 11.33473.235 11.33473.232
9	490073	300x300	3000W	400V	4	11.33473.338 11.33473.234 11.33473.231
10	490056*	300x300	3000W	230V	4	11.33454.247 11.33454.235 11.33454.232
11	490057*	300x300	3000W	400V	4	11.33454.248 11.33454.234 11.33454.231
12	490177	300x300	3000W	440V	4	11.33454.335
13	490141*	300x300	3500W	230V	4	11.33454.242
14	490071*	300x300	4000W	230V	4	11.33454.246 11.33454.238
15	490074*	300x300	4000W	400V	4	11.33454.249 11.33454.237

\* with protector

## hot plates square 300x300mm with connection pins



pos.	order no.	measures (mm)	power	voltage	connections	ref. no.
1	490075	300x300	2500W	230V	3	11.33310.009 11.33310.002
2	490076	300x300	2500W	400V	3	11.33310.008 11.33310.001
3	nla.	300x300	4000W	230V	4	11.33480.002
4	nla.	300x300	4000W	400V	4	11.33480.001

### with screw mounting



pos.	order no.	measures (mm)	power	voltage	connections	ref. no.
1	490078	300x300	3000W	400V	4	11.33470.195
2	490162	300x300	4000W	230V	4	11.33460.192 11.33460.194
3	490161	300x300	4000W	400V	4	11.33460.195

### with tilting attachment



pos.	order no.	measures (mm)	power	voltage	connections	ref. no.
1	490085	300x300	2500W	230V	3	11.33370.247 11.33370.242
2	490086	300x300	2500W	400V	3	11.33370.246 11.33370.241
3	nla.	300x300	2500W	230V	4	11.33460.302
4	490088	300x300	2500W	400V	4	11.33460.349 11.33460.301
5	490089	300x300	4000W	230V	4	11.33460.342 11.33460.308
6	490090	300x300	4000W	400V	4	11.33460.341 11.33460.307

### with bearing edge



pos.	order no.	measures (mm)	power	voltage	connections	ref. no.
1	490095	300x300	2500W	400V	4	11.33471.211
2	490097	300x300	4000W	400V	4	11.33461.266 11.33461.267

# Hot plates

©GEV 2008

## with 1 bent connection



pos.	order no.	measures (mm)	power	voltage	connections	ref. no.
1	490163	300x300	3000W	400V	3	11.33350.507

## hot plates square 400x400mm with 2 bent connections

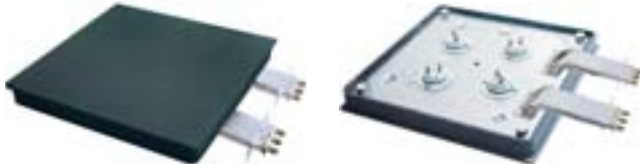

pos.	order no.	measures (mm)	power	voltage	connections	ref. no.
1	490105	400x400	5000W	400V	3+3	11.44650.001

## with mounting bolts

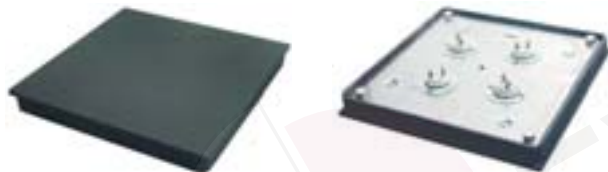

pos.	order no.	measures (mm)	power	voltage	connections	ref. no.
1	490149	400x400	5000W	230V	4+2	11.44870.003
2	490178	400x400	5000W	400V	4+2	11.44870.001

## hot plates rectangular with mounting bolts



pos.	order no.	measures (mm)	power	voltage	connections	ref. no.
1	490110*	348x271	4000W	400V	4	11.32461.201

\* with protector



pos.	order no.	measures (mm)	power	voltage	connections	ref. no.
1	490166	600x300	5000W	400V	4	11.63471.111



pos.	order no.	measures (mm)	power	voltage	connections	suitable for
1	416893	560x285	2x2600W	230V	2x3	Ascobloc Küppersbusch Palux



pos.	order no.	measures (mm)	power	voltage	connections	suitable for
1	490173	560x285	2x3000W	230V	2x4	Küppersbusch



pos.	order no.	measures (mm)	power	voltage	connections	suitable for
1	490165	400x350	4000W	400V	2x3	Therma Electrolux

## heating elements

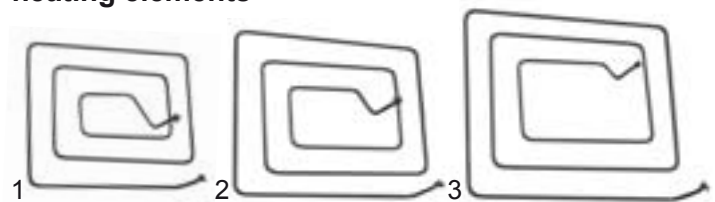

item	order no.	measures (mm)	power	voltage	mounting	suitable for
1	415577	245x295	1160W	400V	inner	Therma Electrolux
2	415576	275x320	1335W	400V	centre	
3	415575	360x395	1505W	400V	outer	

## cooking rings



item	order no.	ø (mm)	power	voltage	ref. no.
1	490032	80	350W	230V	
2	490022	145	1000W	230V	12.14025.142
3	490155*	160	1000W	230V	

\*seventh act rings

H

Hot plates

## large hot plate heating elements

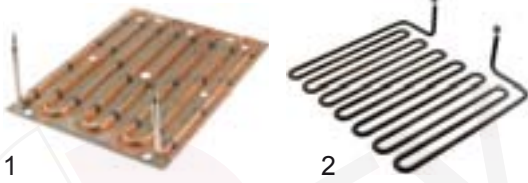

item	order no.	measures (mm)	power	voltage	suitable for
1	418009	380x287	4000W	400V	Juno Electrolux
2	418701	330x300	4000W	400V	Therma Electrolux

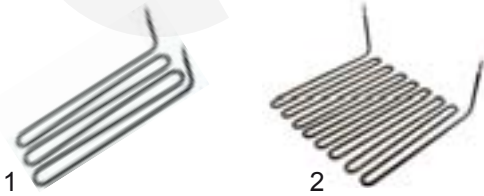

item	order no.	measures (mm)	power	voltage	suitable for
1	418718	265x100	1500W	230V	Silko
2	416894	265x245	3500W	230V	Palux



pos.	order no.	measures (mm)	power	voltage	suitable for
1	418692	275x260	3860W	400V	Wamsler

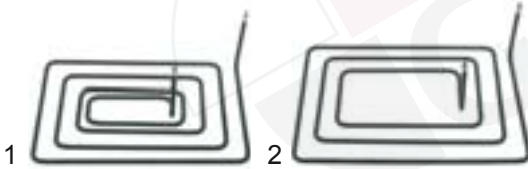

item	order no.	measures (mm)	power	voltage	suitable for
1	418699	345x230	2000W	400V	Juno Electrolux
2	418700	380x265	2000W	400V	Juno Electrolux

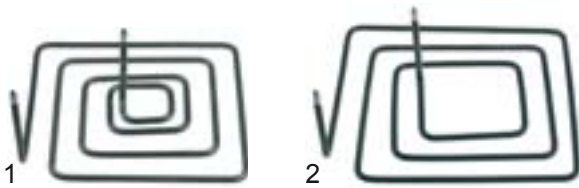

item	order no.	measures (mm)	power	voltage	suitable for
1	418697	270x230	2000W	400V	Juno Electrolux
2	418698	300x260	2000W	400V	Juno Electrolux



item	order no.	measures (mm)	power	voltage	suitable for
1	418704	255x240	1160W	400V	Lohberger
2	418705	270x270	1335W	400V	
3	418706	300x300	1505W	400V	

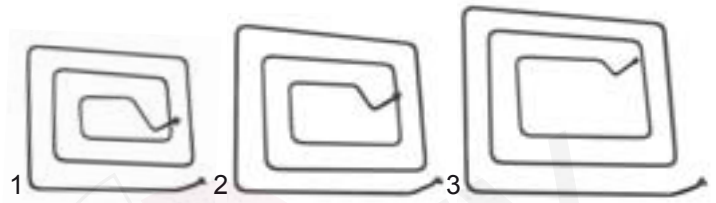

item	order no.	measures (mm)	power	voltage	mounting	suitable for
1	415577	245x295	1160W	400V	inner	Therma Electrolux
2	415576	275x320	1335W	400V	mitte	
3	415575	360x395	1505W	400V	outer	

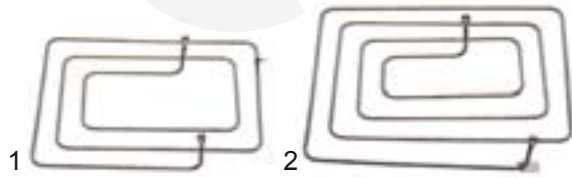

item	order no.	measures (mm)	power	voltage	suitable for
1	415205	300x220	1700W	400V	Ambach
2	415206	355x340	2000W	400V	

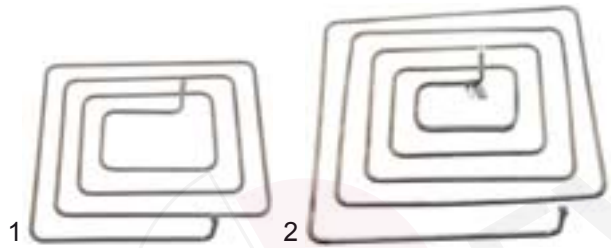

item	order no.	measures (mm)	power	voltage	suitable for
1	416948	275x305	1700W	400V	Ambach
2	416949	300x340	2000W	400V	

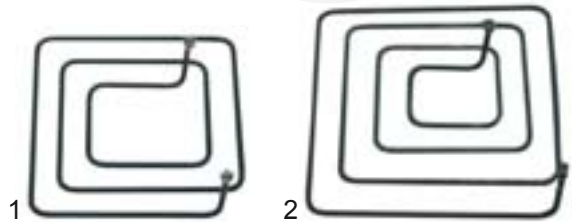

item	order no.	measures (mm)	power	voltage	suitable for
1	415862	218x228	1350W	400V	Ambach
2	415863	245x260	1650W	400V	

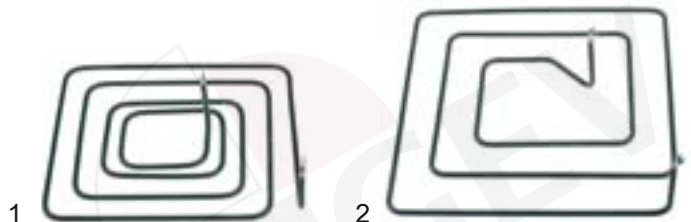

item	order no.	measures (mm)	power	voltage	suitable for
1	418707	230x265	1500W	230V	EKU
2	418706	300x300	1500W	230V	

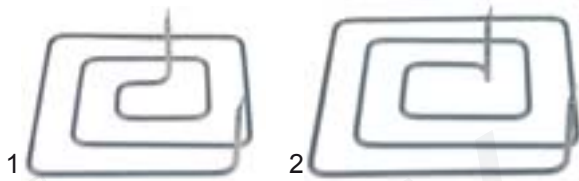

item	order no.	measures (mm)	power	voltage	mounting	suitable for
1	418486	230x230	900W	400V	inner	Salvis Franke
2	418485	258x258	1100W	400V	mitte inner	

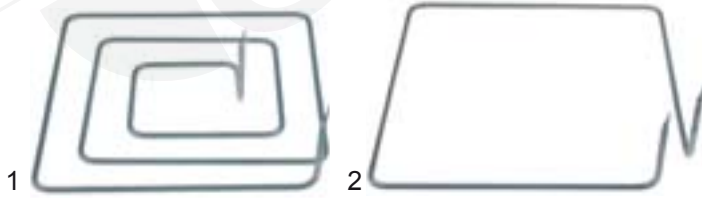

item	order no.	measures (mm)	power	voltage	mounting	suitable for
1	418484	284x284	1300W	400V	mitte outer	Salvis Franke
2	418483	315x315	650W	400V	outer	



item	order no.	measures (mm)	power	voltage	suitable for
1	418255	330x54	600W	80V	MKN 700 series
2	490022	ø145	1000W	230V	MKN 850 series

## radiation heaters



item	order no.	ø (mm)	power	voltage	suitable for
1	490139	250	2500/1100W	230V	Ascobloc Küppersbusch Palux Mareno
2	490146	250	2500/1250W	230V	Ascobloc Küppersbusch Palux

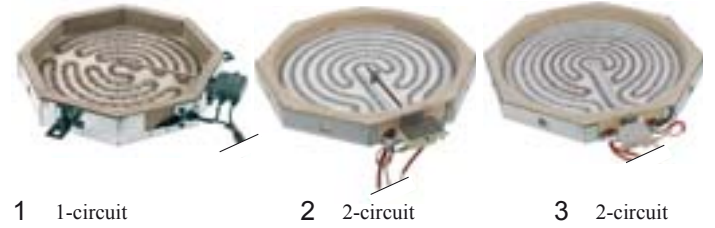

item	order no.	measures (mm)	power	voltage	suitable for
1	416963	230x230	2400W	230V	Mareno
2	490152	300x300	2500W	230V	Mareno
3	490079	300x300	3400W	230V	Mareno



item	order no.	measures (mm)	power	voltage	suitable for
1	490168	295x295	3500W	400V	Ascobloc
2	490159	300x300	3500W	240V	Zanussi Electrolux



## radiation heater round 1-circuit 7-position control



1 with temperature signalization

2 without temperature signalization

item	order no.	ø (mm)	power	voltage	connections	product	ref. no.
1	490045	165	1200W	230V	4+2	EGO	10.74431.004
1	490046	200	1700W	230V	4+2	EGO	10.78431.004
1	490047	230	2100W	230V	4+2	EGO	10.71431.004
2	490169	165	1200W	230V	4	EGO	10.74433.004
2	490170	200	1700W	230V	4	EGO	10.78433.004
2	490132	230	2100W	230V	4	EGO	10.71421.004 10.71423.004 10.81351.004

## energy control (coil heater)



1 with temperature signalization

2 with temperature signalization and pan sensor

item	order no.	ø (mm)	power	voltage	connections	product	ref. no.
1	490024	165	1200W	230V	2+2	EGO	10.74631.004
1	490025	200	1700W	230V	2+2	EGO	10.78631.004
1	490026	230	2100W	230V	2+2	EGO	10.71631.004
1	490150	250	2500W	230V	2+2	EGO	10.73631.004
2	490092	200	1800W	230V	2+2	Cerama Speed	200N4-2599

## energy control (ribbon heater)

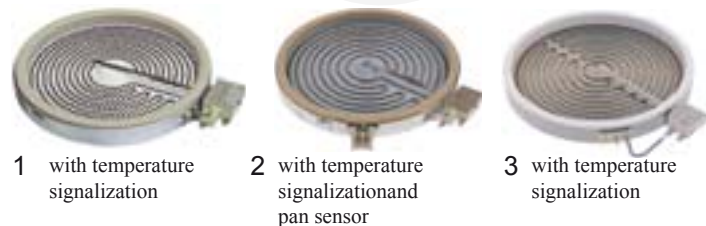

1 with temperature signalization

2 with temperature signalization and pan sensor

3 with temperature signalization

item	order no.	ø (mm)	power	voltage	connections	product	ref. no.
1	490041	165	1200W	230V	2+2	EGO	10.54111.004
1	490042	200	1800W	230V	2+2	EGO	10.58111.004
1	490043	230	2300W	230V	2+2	EGO	10.51111.004
1	490136	230	2300W	230V	2+2	EGO	10.51113.004
1	490131	250	2500W	230V	2+2	EGO	10.53111.106
2	490051	230	2300W	230V	2+2	EGO	10.51121.004
3	490116	165	1200W	230V	2+2	Cerama Speed	165N8 L6090
3	490113	200	1800W	230V	2+2	Cerama Speed	200N8 L5708R
3	490091	230	2100W	230V	2+2	Cerama Speed	230N7- L4728R

## radiation heater round 2-circuit energy control (coil heater)



1 with temperature signalization

2 without temperature signalization

item	order no.	ø (mm)	power	voltage	connections	product	ref. no.
1	490040	200	1800/ 600W	230V	3+2	EGO	10.78661.004 10.87261.004
1	490028	230	2100/ 650W	230V	3+2	EGO	10.71261.004 10.81261.004
2	490146	250	2500/ 1250W	230V	3	EGO	10.73601.004

## energy control (ribbon heater)

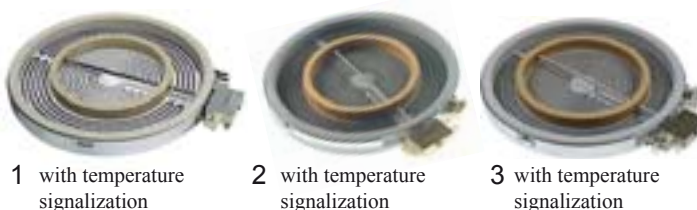

1 with temperature signalization

2 with temperature signalization and pan sensor

3 with temperature signalization

item	order no.	ø (mm)	power	voltage	connections	product	ref. no.
1	490119	200	1700/ 600W	230V	3+2	EGO	10.58211.004
1	490044	230	2200/ 750W	230V	3+2	EGO	10.51211.004
1	490139	250	2500/ 1100W	230V	3+2	EGO	10.53211.004
2	490135	230	2200/ 750W	230V	3+2	EGO	10.51213.004
3	490157	230	2200/ 1000W	230V	3+2	EGO	10.51213.432



with temperature signalization

pos.	order no.	ø (mm)	power	voltage	connections	product	ref. no.
1	490114	230	2200/ 750W	230V	3+2	Cerama Speed	230T8- L6384D

## radiation heater octagonal 1-circuit energy control (coil heater)

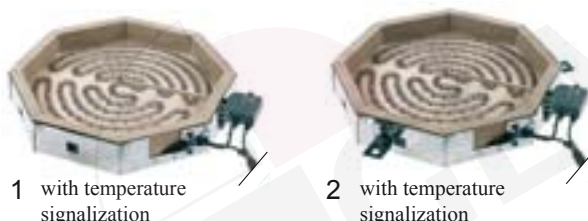

1 with temperature signalization

2 without temperature signalization

item	order no.	measures (mm)	power	voltage	connections	product	ref. no.
1	490151	230x230	2100W	230V	2+2	AD	100.382
2	416963	230x230	2400W	230V	2+2	AD	100.154

## radiation heater octagonal 2-circuit energy control (coil heater)

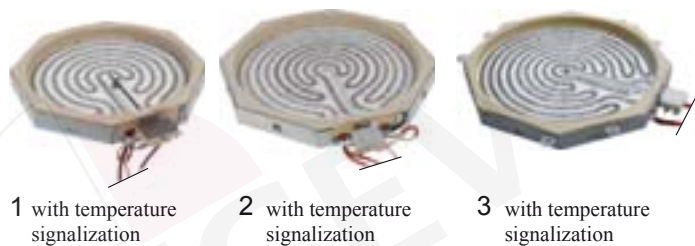

item	order no.	measures (mm)	power	voltage	connections	product	ref. no.
1	490152	300x300	2500W	230V	3+2	AD	100.298
2	490079	300x300	3400W	230V	4+2	AD	100.299 100.381
3	490153	300x300	3400W	230V	4+2	AD	100.370

## radiation heater square



item	order no.	measures (mm)	power	voltage	connections	suitable for
1	416192	225x225	750W	230V	2	CF
2	490168	295x295	3500W	400V	2+2	Ascobloc



item	order no.	measures (mm)	power	voltage	connections	product	ref. no.
1	490144	300x300	2500W	400V	3	EGO	10.77828.001
1	490159	300x300	3500W	230V	3	EGO	10.77828.002 10.77828.003 10.83816.120
1	490145	300x300	3500W	400V	3	EGO	10.77828.008
1	490008	300x300	4000W	400V	3	EGO	10.83816.060 10.77823.006
2	490108	300x300	2500W	400V	3+2	EGO	10.77848.001
2	490143	300x300	3500W	400V	3+2	EGO	10.77848.008
2	490009	300x300	4000W	400V	3+2	EGO	10.77843.006 10.83846.060

## radiation heater rectangular/double ceramic cook tops



pos.	order no.	measures (mm)	power	voltage	suitable for
1	416895	300x530	2x2600W	230V	Küppersbusch, Ascobloc

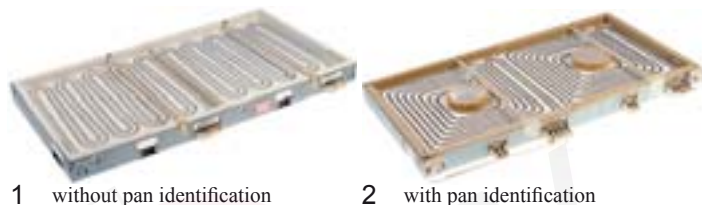

item	order no.	measures (mm)	power	voltage	product	ref. no.
1	490148	300x570	2x2500W	400V	EGO	10.83050.005
2	490147	300x570	2x3500W	230V	EGO	10.77058.019

## radiation heater rectangular miscellaneous

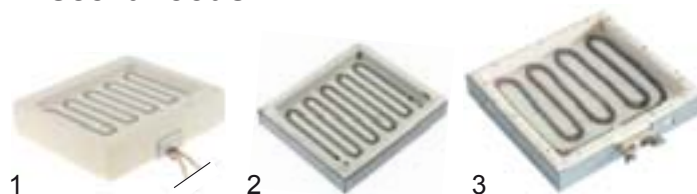

item	order no.	measures (mm)	power	voltage	connections	suitable for
1	416015	135x150	600W	230V	2	Polydor
2	490142	133x151	750W	230V	2	Inoksan
3	416165	170x180	1500W	230V	2	Star 10

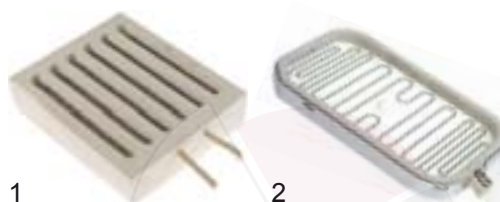

item	order no.	measures (mm)	power	voltage	connections	suitable for
1	418260	175x211	1600W	230V	2	Naomi
2	416001	165x265	1500W	230V	2	Bartscher Giorik

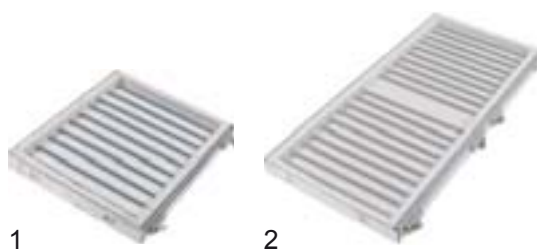

item	order no.	measures (mm)	power	voltage	connections	product	ref. no.
1	416655	240x290	2000W	230V	2	IRCA	3027287
2	416656	240x492	2x2000W	230V	2+2	IRCA	6349400



pos.	order no.	measures (mm)	power	voltage	connections	product	ref. no.
1	490172	280x400	4500W	400V	2x2	IRCA	W220 8178148

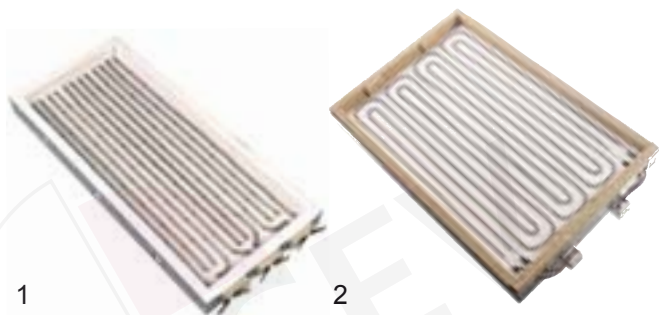

item	order no.	measures (mm)	power	voltage	connections	product	ref. no.
1	416166	175x380	3x1100W	230V	3x2	IRCA	X809 7100601
2	416897	275x415	3500W	400V	2x2	-	100456



item	order no.	measures (mm)	power	voltage	connections	product	ref. no.
1	416934	480x470	3x1300W	400V	3x2	-	-
2	416937	320x455	3x1050W	230V	3x2	-	-

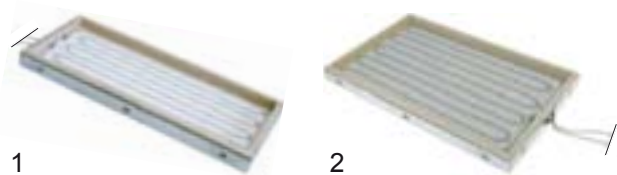

item	order no.	measures (mm)	power	voltage	connections	product	ref. no.
1	416545	193x452	1500W	230V	2	AD	100
2	416546	276x452	2500W	230V	2	AD	100.105

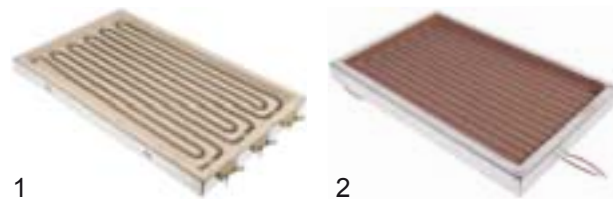

item	order no.	measures (mm)	power	voltage	connections	product	ref. no.
1	418230	260x425	3x1334W	230V	3x2	IRCA	4155 6296132
2	416921	295x462	2500W	230V	2	-	-

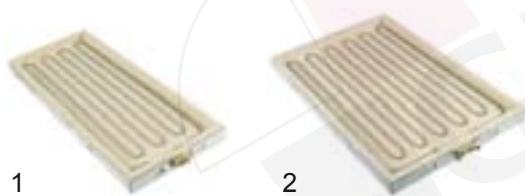

item	order no.	measures (mm)	power	voltage	connections	product	ref. no.
1	418029	193x450	1500	230V	2	IRCA	V117005
2	418030	295x450	2500	230V	2	IRCA	V110018

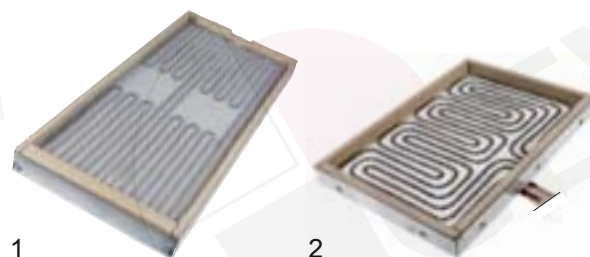

item	order no.	measures (mm)	power	voltage	connections	product	ref. no.
1	416939	285x650	2x860W	230V	2x2	-	-
2	490156	400x280	3x3000W	400V	6	AD	100.204

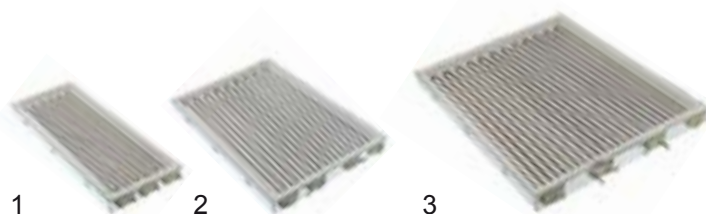

item	order no.	measures (mm)	power	voltage	connections	product	ref. no.
1	416998	165x410	3x900W	230V	3x2	IRCA	8025319
2	416999	280x410	3x1667W	230V	3x2	IRCA	4508
3	418000	340x432	3x3000W	400V	3x2	IRCA	7278571 4509

## accessories hot plates miscellaneous



item	order no.	description	EGO no.
1	550127	connecting piece/ connecting fitting 3+1	17.34310.000
2	550128	connecting piece/ connecting fitting 4+1	17.34410.000
3	550129	bearing screw	

## 4-position switches 16A



item	order no.	connection	signal	shaft length (mm)	EGO no.
1	300007	2-pole	yes	23	49.24215.520
2	300022	2-pole	no	23	49.24015.500



item	order no.	connection	signal	shaft length (mm)	EGO no.
1	300023	2-pole	yes	23	49.24215.000
2	300094	2-pole	yes	15	49.24215.001

## 4-position switches 32A



item	order no.	connection	signal	shaft length (mm)	EGO no.
1	300192	2-pole	no	23	43.24032.000
2	300103	2-pole	yes	23	43.24232.000



item	order no.	connection	signal	shaft length (mm)	EGO no.
1	300194	2-pole	yes	23	43.24216.000
2	300110	2-pole	yes	35	43.24216.020



item	order no.	connection	signal	shaft length (mm)	EGO no.
1	300174	2-pole	yes	23	43.24432.000
2	300104	3-pole	yes	23	43.34232.000

## 5-position switches 16A



pos.	order no.	connection	signal	shaft length (mm)	EGO no.
1	345199	2-pole	yes	23	49.25215.530

## 5-position switches 32A



item	order no.	connection	signal	shaft length (mm)	EGO no.
1	300133	2-pole	yes	23	43.25232.000
2	300105	3-pole	yes	23	43.35232.000



pos.	order no.	connection	signal	shaft length (mm)	EGO no.
1	300075	2-pole	yes	23	43.25232.020

## 7-position switches 16A

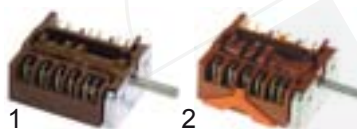

item	order no.	connection	signal	shaft length (mm)	EGO no.
1	300031	2-pole	yes	23	46.27266.500
2	300177	2-pole	yes	23	46.27266.813



item	order no.	connection	signal	shaft length (mm)	EGO no.
1	301250	2-pole	yes	23	46.27266.817
2	300079	2-pole	yes	23	46.27262.010



item	order no.	connection	signal	shaft length (mm)	EGO no.
1	300026	2-pole	no	27	49.27016.200
2	300024	2-pole	no	23	49.27015.000
3	300003	2-pole	no	23	49.27015.500



item	order no.	connection	signal	shaft length (mm)	EGO no.
1	300025	2-pole	yes	27	49.27215.000 49.27215.746
2	300004	2-pole	yes	23	49.27215.520 49.27215.747 49.27215.500

## 7-position switch 32A



pos.	order no.	connection	signal	shaft length (mm)	EGO no.
1	300106	3-pole	yes	23	43.27232.000

## energy regulators 1-circuit EGO



**abbreviations:**  
 R = clockwise  
 L = anti clockwise  
 L1 = hole distance 28mm  
 M1 = M12x1  
 M2 = 3/8" - 24UNF

item	order no.	switch power	function	fixing	shaft length (mm)	power supply	schematic	ref. no.
1	380015	13A/230V	R	L1	23	6-100%	1	50.57021.010 50.37021.000 50.17021.000
1	380019	13A/240V	R	L1	23	6-100%	1	50.57071.010 50.37071.000
1	380034	13A/240V	R	L1	23	6-100%	1	50.57079.021
1	380013	7A/400V	R	L1	23	6-100%	1	50.57031.010 50.37051.060 50.17031.000
1	380009	13A/230V	L	L1	23	6-100%	1	50.57020.010 50.37010.000 50.57010.010
1	380014	7A/400V	L	L1	23	6-100%	1	50.57030.010
2	380036	13A/230V	R	M1	23	6-100%	1	50.57024.010
2	380035	13A/240V	L	M2	19	22-100%	2	50.59070.048
2	380046	13A/240V	L	M2	23	22-100%	2	50.59070.051

## energy regulators 1-circuit DREEFS

discontinued version only for replacement purposes



**abbreviations:**  
 R = clockwise  
 L = anti clockwise  
 L1 = hole distance 28mm

item	order no.	switch power	function	fixing	shaft length (mm)	power supply	schematic	ref. no.
1	380005	16A/230V	L	L1	23	6-100%	8	SRIII/300
2	380017	16A/230V	R	L1	23	6-100%	8	SRIII/229

## energy regulators 1-circuit DIAMOND



**abbreviations:**  
 R = clockwise  
 L1 = hole distance 28mm  
 M2 = 3/8" - 24UNF

item	order no.	switch power	function	fixing	shaft length (mm)	power supply	schematic	ref. no.
1	380032	13A/230V	R	L1	23	6-100%	1	45ER104C1
2	380038	13A/24V	R	M2	26	6-100%	3	35ERE105024V
2	380037	13A/230V	R	M2	26	6-100%	3	35ERE101230V
2	380039	13A/400V	R	M2	26	6-100%	3	35ERE104400V

## energy regulators 1-circuit ROBERTSHAW



**abbreviations:**  
 L = anti clockwise  
 L2 = hole distance 19mm  
 M2 = 3/8" - 24UNF

item	order no.	switch power	function	fixing	shaft length (mm)	power supply	schematic	ref. no.
1	380041	15A/240V	L	L2	23	5-100%	2	INF2401165
1	380042	15A/240V	L	L2	35	22-100%	2	INF240TP1211
1	380043	15A/240V	L	L2	35	5-100%	2	INF240TP1211B
2	380044	15A/240V	L	M2	26	22-100%	2	INF240.2B

## energy regulators 1-circuit SUNVIC



**abbreviations:**  
 R = clockwise  
 M2 = 3/8" - 24UNF

item	order no.	switch power	function	fixing	shaft length (mm)	power supply	schematic	ref. no.
1	380040*	13A/240V	R	M2	27	5-100%	4	TYJ6202(01B)
2	112520	knob (shaft hole 4,8x4,1mm)						

\* attention: shaft 4,8x4,1mm

## energy regulators 2-circuit EGO



pos.	order no.	switch power	function	fixing	shaft length (mm)	power supply	schematic	ref. no.
1	380027	13A/230V	R	L1	23	6-100%	5	50.55021.100 50.55071.100
2	380028	7A/400V	R	L1	23	6-100%	5	50.55031.100

## energy regulators 2-circuit EGO



**abbreviations:**  
R = clockwise  
L1 = hole distance 28mm

item	order no.	switch power	function	fixing	shaft length (mm)	power supply	schematic	ref. no.
1	380004	13A/230V	R	L1	23	6-100%	6	50.67021.590
2	380024	13A/230V	R	L1	23	6-100%	7	50.67079.601

## thermostats



item	order no.	description	suitable for	ref. no.
1	375425	thermostat 360°C, 1-pole	Juno	76.77123.000
2	375570	thermostat 470°C, 1-pole	Electrolux	55.34683.040



item	order no.	description	suitable for	ref. no.
1	375105	thermostat 500°C, 1-pole	Ambach	EM-1 60/60001999
2	375533	thermostat 440°C, 3-pole		EMF-123 TN 60002163



item	order no.	description	suitable for	ref. no.
1	375038	thermostat 300°C, 3-pole	Juno Electrolux	55.34055.020
1	375872	thermostat 490°C, 3-pole sensor 90° curved	Wamsler	55.34083.050
2	375096	thermostat 450°C, 4-pole	MKN Ascobloc	55.40083.010
3	375879	thermostat 440°C, 3-pole	Lohberger	55.34683.060
3	375691	thermostat 390°C, 3-pole	Palux	55.34673.010

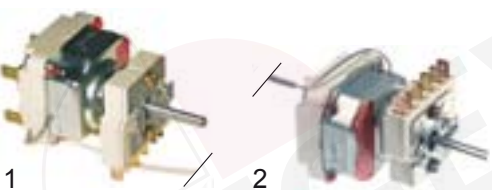

item	order no.	temperature range	rotation angle (°)	contacts	ref. no.
1	375246	100-645°C	270	2NO	55.34683.010
2	375140	100-650°C	318	2NO INC	55.34683.800



item	order no.	description	suitable for	ref. no.
1	300080	outer switch	Mareno	49.41015.300
2	550060	retainer		
3	375884	thermostat 400		55.19082.812



item	order no.	description	suitable for	ref. no.
1	375877	thermostat	Therma Electrolux	55.34083.220 49.41015.300
2	375773	limiter 440°C	Küppersbusch Palux Ascobloc	55.13183.020



item	order no.	description	suitable for	ref. no.
1	375878	safety thermostat 570°C	Lohberger	55.32582.040
1	375681	safety thermostat 520°C	Palux	55.32582.030
1	375890	safety thermostat 650°C	Silko	55.32583.809
2	390609	contact thermostat	Küppersbusch Palux Ascobloc	
3	375880	thermostat 57°C fan	EKU	55.13312.050

## electronic regulations

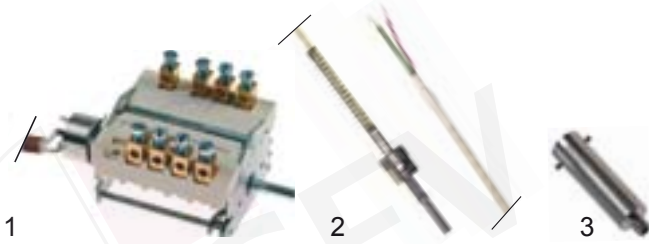

item	order no.	description	suitable for	ref. no.
1	346984	switch with potentiometer		0K5063 180255422
2	379092	sensor	Therma Electrolux	0K5058 18025415
3	379094	sensor holder 39mm		0G2155
3	378128	sensor holder 59mm		0KE127

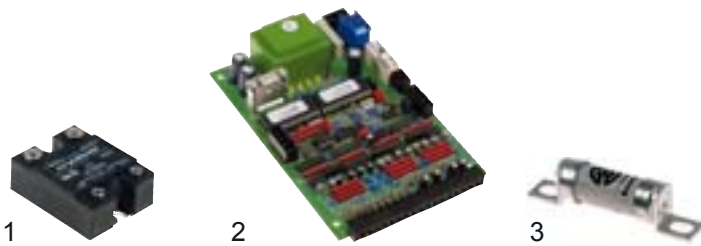

item	order no.	description	suitable for	ref. no.
1	401671	semiconductor relay		0K5070 18025431
2	401964	electronics	Therma Electrolux	0K5071 18025432
3	358397	fuse 25A		0K5074 18025434

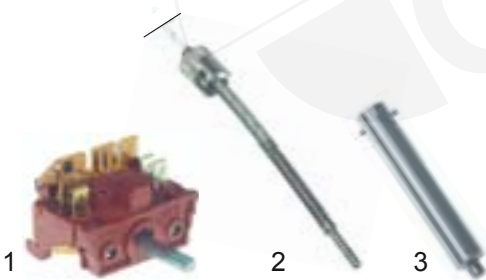

item	order no.	description	suitable for	ref. no.
1	346593	switch		1G960000
2	379882	sensor	Salvis Franke	1G943000
3	379881	sensor holder		1G534536

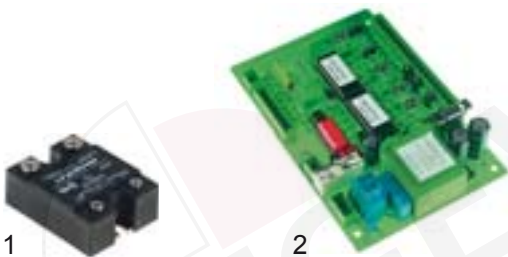

item	order no.	description	suitable for	ref. no.
1	401563	semiconductor relay	Salvis Franke	1G533279
2	401562	electronics		1G534537



item	order no.	description	suitable for	ref. no.
1	300002	outer switch 4-pole		245599
2	400178	potentiometer	Juno Electrolux	0H7178 867041
3	400079	Triac		0H7060 585601

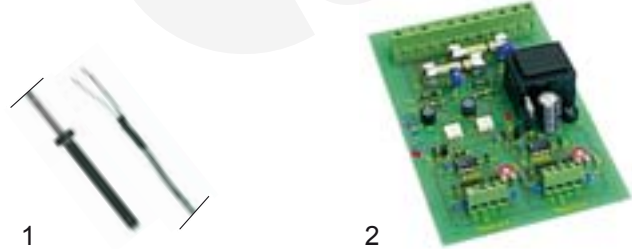

item	order no.	description	suitable for	ref. no.
1	379148	sensor	Juno	0H6267
2	400177	electronic thermostat	Electrolux	0H6144



item	order no.	description	suitable for	ref. no.
1	347015	switch		0101420
2	402055	potentiometer	Silko	0101932
3	350086	buzzer		919008

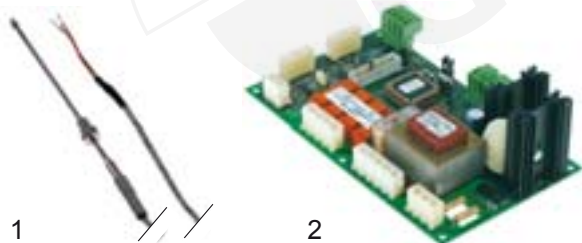

item	order no.	description	suitable for	ref. no.
1	378129	sensor	Silko	0100167
2	402056	electronics		0101930



pos.	order no.	description	application	ref. no.
1	400074	Pan detection electronics 400V for square elements	commercial kitchens	75.05011.000
2	400411	Pan detection electronics 230V for square elements	commercial kitchens	75.05011.001
3	401393	Pan detection electronics 230V for round elements	domestic	75.05011.004

## knobs and symbols



item	order no.	description
1	112489	universal knob without adapter ø 52mm
2	112303	universal knob without adapter ø 72mm
3	112311	adapter 6x4.6

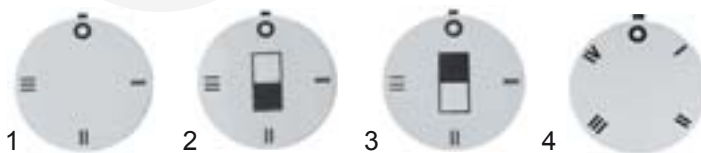

item	order no.	description
1	110521	4 position symbol
2	110507	4 position symbol in the front
3	110508	4 position symbol at the back
4	112416	5 position symbol



item	order no.	description
1	110522	7 position symbol
2	110509	7 position symbol controlling front
3	110510	7 position symbol controlling back
4	112444	thermostat symbol 1-10 RA 270°



item	order no.	description
1	112445	thermostat symbol 1-10 RA 318°
2	112521	energy regulator symbol 1-circuit anti clockwise
3	112430	energy regulator symbol 1-circuit clockwise
4	112431	energy regulator symbol 2-circuit clockwise



item	order no.	description
1	112173	universal knob without adapter ø 62mm
2	112311	adapter 6x4.6
3	112388	central symbol



item	order no.	description
1	110553	4 position symbol
2	111553	5 position symbol
3	110552	7 position symbol
4	110540	thermostat symbol 1-10 RA 270°



item	order no.	description
1	112295	thermostat symbol 1-10 RA 318°
2	112522	energy control symbol 1-circuit anti clockwise
3	110551	energy control symbol 1-circuit clockwise
4	111560	energy control symbol 2-circuit clockwise



item	order no.	description
1	112172	universal knob without adapter ø 70mm
2	112311	adapter 6x4.6



item	order no.	description
1	112212	4 position symbol
2	112321	5 position symbol
3	112213	7 position symbol
4	112247	thermostat symbol 1-10 RA 270°



item	order no.	description
1	112249	thermostat symbol 1-10 RA 318°
2	112524	energy control symbol 1-circuit anti clockwise
3	112223	energy control symbol 1-circuit clockwise
4	112323	energy control symbol 2-circuit clockwise





item	order no.	description
1	110232	4 position switch ø50mm
2	110233	5 position switch ø50mm
3	110234	7 position knob ø50mm
4	110235	energy regulator 1-3 ø50mm



item	order no.	description
1	110237	energy regulator 1-10 clockwise ø50mm
2	110238	energy regulator 1-10 anti clockwise ø50mm
3	111861	thermostat 1-10 RA 270°
4	110236	thermostat RA 270° ø50mm



pos.	order no.	description
1	110075	energy regulator 1-3 ø50mm



item	order no.	description
1	110110	4 position switch ø60mm
2	110111	5 position switch ø60mm
3	110112	7 position knob ø60mm
4	110117	energy regulator 1-3 ø60mm

## ceramic-glass maintenance



item	order no.	description
1	890238	glass ceramic cleaner 200ml
2	890239	glass ceramic cleaner 250g
3	890240	glass ceramic scraper
4	890241	spare blades Qty 10 pieces

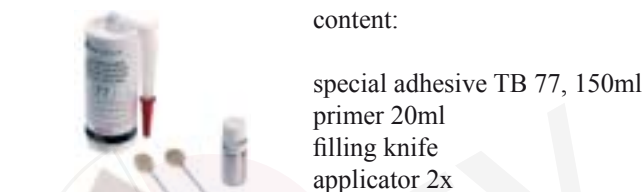

content:

special adhesive TB 77, 150ml  
primer 20ml  
filling knife  
applicator 2x

pos.	order no.	description
1	890242	repair adhesive kit for glass ceramic knobs (TOMABOND)



item	order no.	description
1	890257	adhesive primer 125ml
2	890258	special adhesive TB 77, 310ml, colour anthracite (TOMABOND)
3	890060	special adhesive Pactan 310ml

## sealing cords round, twisted

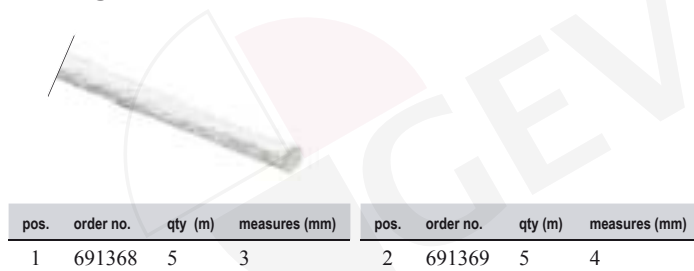

pos.	order no.	qty (m)	measures (mm)	pos.	order no.	qty (m)	measures (mm)
1	691368	5	3	2	691369	5	4

## sealing cords round, braided



pos.	order no.	qty (m)	ø (mm)	pos.	order no.	qty (m)	ø (mm)
1	691361	5	5	5	691364	5	12
2	691362	5	6	6	693735	5	15
3	691363	5	8	7	693736	5	20
4	693734	5	10	8	693737	5	25

## sealing cords square, braided



pos.	order no.	qty (m)	measures (mm)	pos.	order no.	qty (m)	measures (mm)
1	691365	5	5x5	4	693738	5	10x10
2	691366	5	6x6	5	693739	5	12x12
3	691367	5	8x8	6	693740	5	14x14

## EGOTHERM heating plates 1-circuit



item	order no.	power	voltage	thermostat	safety-thermostat	EGO no.
1	418473	1800W	230V	-	-	28.06018.300
2	415336	500W	230V	128°C (375300)	-	28.06013.100
2	415760	1800W	230V	128°C (375300)	-	28.06013.200
3	418429	1800W	230V	-	250°C (375137)	28.06020.000



item	order no.	power	voltage	thermostat	safety-thermostat	EGO no.
1	418466	1800W	230V	128°C (375782)	-	28.06018.200
2	418430	1800W	230V	128°C (375782)	250°C (375137)	28.06020.100
2	418482	2000W	230V	128°C (375782)	250°C (375137)	28.06019.900

## EGOTHERM heating plates 2-circuit



item	order no.	power	voltage	thermostat	safety-thermostat	EGO no.
1	415337	1800W	230V	128°C (375300)	250°C (375137)	28.06013.300
1	415661	3000W	230V	128°C (375300)	250°C (375137)	28.06013.400
2	418242	1800W	230V	117°C (375792)	250°C (375793)	28.06014.000
3	418467	1800W	230V	105°C (375794)	250°C (375137)	28.06019.500

## accessories EGOtherm heating plates thermostats



item	order no.	temperature range	capillary (mm)	EGO no.
1	375300	35–128°C	880	55.14022.100
1	375792	30–117°C	990	55.14029.090
2	375794	30–105°C	870	55.13622.140
2	375782	30–128°C	870	55.13622.120

## safety thermostats

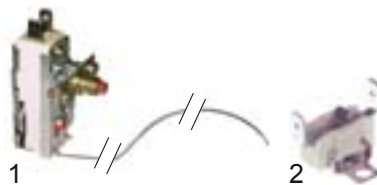

item	order no.	temperature range	capillary (mm)	EGO no.
1	375137	250°C	880	55.14542.040
1	375793	250°C	990	55.14549.020
2	390410	200°C	-	960.009

## miscellaneous



item	order no.	description
1	520324	flange ring
2	520323	gasket

## schematics energy regulators

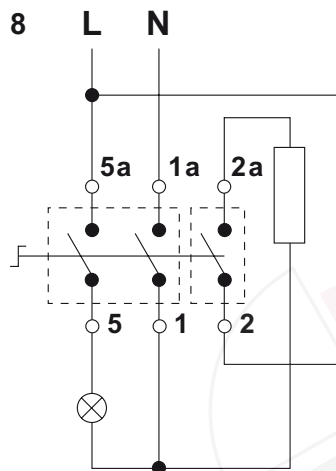
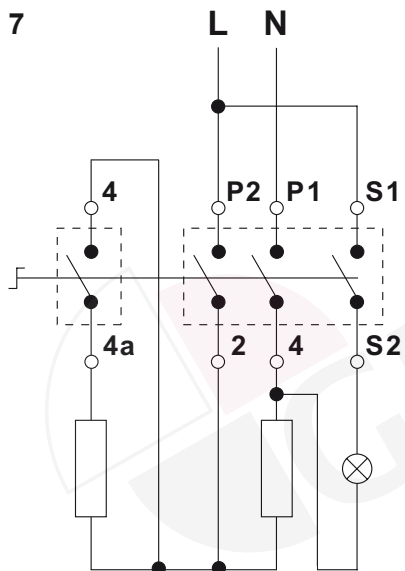
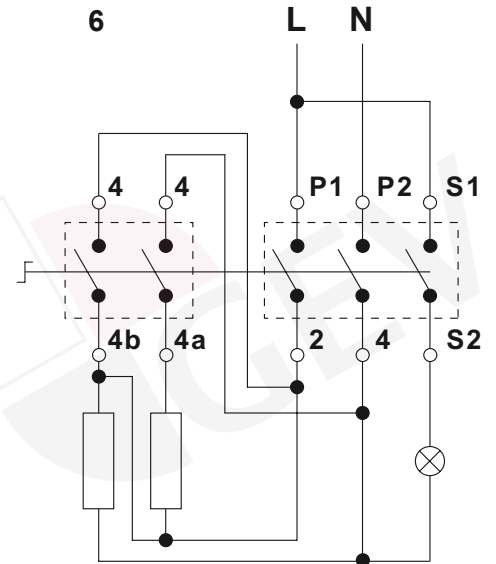
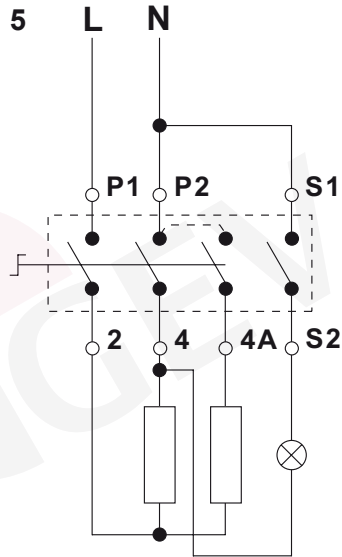
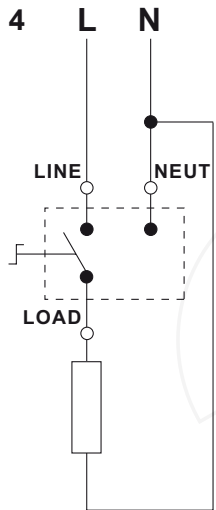
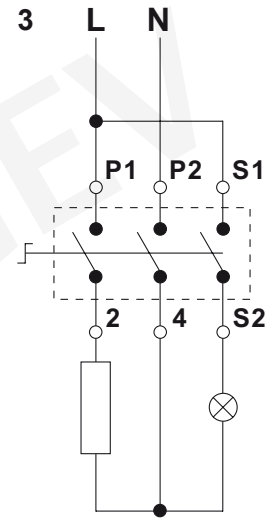
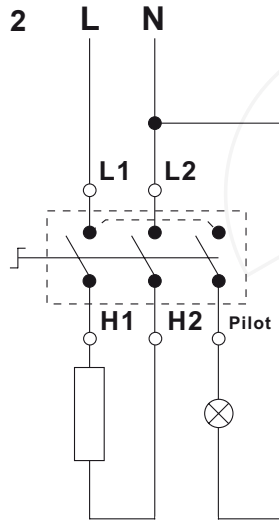
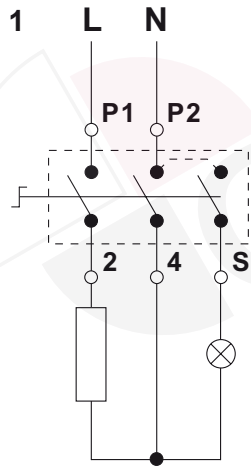

## schematics hot plates

hot plate 3 connections  
2-pole 4-position switch

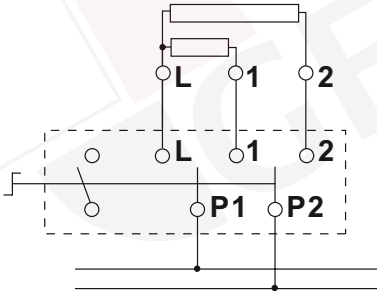

hot plate 4 connections  
2-pole 4-position switch

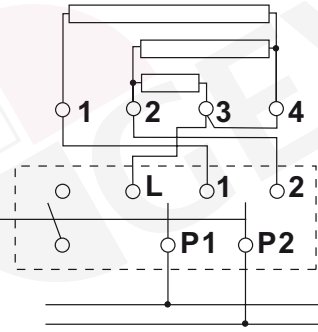

hot plate 4 connections  
2-pole 5-position switch

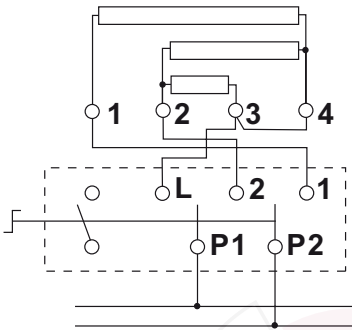

hot plate 4 connections  
2-pole 7-position switch

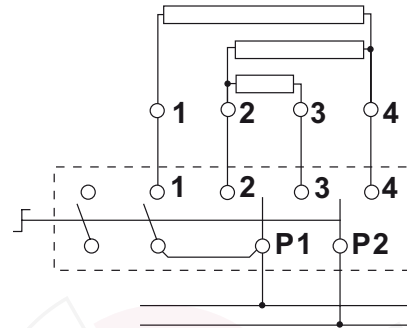

hot plate 4 connections  
3-pole 4-position switch

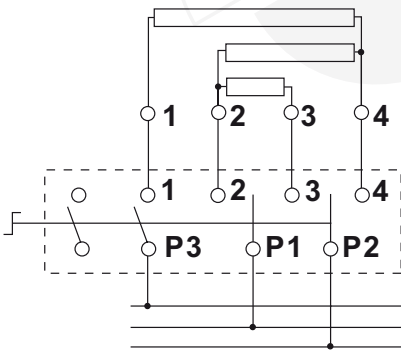

hot plate 4 connections  
3-pole 5-position switch

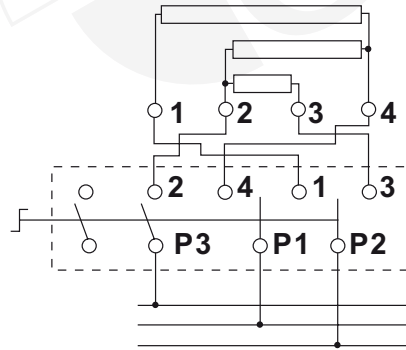

hot plate 2x3 connections  
2x2-pole 4-position switch

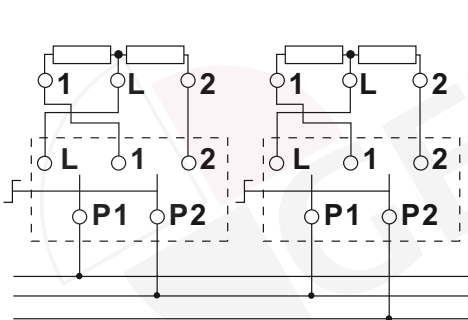

hot plate 2x3 connections  
1x3-pole 4-position switch

